

clima

thermostat/humidistat

CAREL



(ENG) User manual

Contents

| | |
|--|-----------|
| 1. INTRODUCTION | 7 |
| 1.1 Models available | 7 |
| 2. INSTALLATION | 9 |
| 2.1 Assembly | 9 |
| 2.2 Dimensions..... | 9 |
| 2.3 Electrical connections:..... | 10 |
| 3. USER INTERFACE AND MODES | 11 |
| 3.1 Display and buttons..... | 11 |
| 3.2 Description of the buttons | 11 |
| 4. CONFIGURATIONS | 13 |
| 4.1 Configuring the operating modes | 13 |
| 4.2 Main parameters to be set..... | 14 |
| 4.3 Additional functions..... | 14 |
| 5. FUNCTIONS | 19 |
| 5.1 (T) temperature control with single output..... | 19 |
| 5.2 (T2) temperature control with double output..... | 19 |
| 5.3 (H) humidity control..... | 20 |
| 5.4 (T+H) temperature and humidity control | 20 |
| 5.5 (T2 + H) two-stage temperature and humidity control..... | 21 |
| 5.6 (T2A) automatic temperature control only | 21 |
| 5.7 (T2A + H) automatic temperature and humidity control | 22 |
| 5.8 (T+H radiant ON/OFF) ON/OFF mode for radiant floor systems | 24 |
| 5.9 (T+H radiant proportional) proportional control mode for radiant floor systems (code ADCF000610)..... | 24 |
| 6. TABLE OF PARAMETERS | 26 |
| 6.1 Description of the parameters for the standard version | 26 |
| 6.2 Additional parameters, available in version T+H for proportional control of radiant systems (cod. ADCF000610)..... | 29 |
| 7. ALARMS AND SIGNALS | 29 |
| 7.1 Table of alarms..... | 29 |
| 8. TECHNICAL SPECIFICATIONS | 30 |
| 8.1 Technical specifications | 30 |
| 8.2 Wiring..... | 30 |
| 9. APPENDIX | 31 |
| 9.1 Supervisor parameters for CAREL and Modbus® protocol | 31 |
| 9.2 Software updates | 36 |

1. INTRODUCTION

The CLIMA thermostat-humidistat terminal is an instrument that can, according to the model chosen, control the ambient temperature and humidity.

It can be used in various operating modes, which are described in this manual. Depending on the model, the following functions/components are included:

- Built-in NTC temperature and humidity sensor with digital measurement. Available on all humidistat codes, not available on thermostat-only codes.
- Remote NTC temperature sensor, with specific temperature compensation functions in the controller.
- Digital input from voltage-free or 24 Vac contact, with control function for alarms, on/off, etc.

- 0 to 10 V output for controlling humidifiers, air-conditioners or condensing units.
- Two relay outputs with class 2 insulation from the rest of the instrument for controlling the actuators.
- Advanced algorithms for operation in heating, cooling or automatic mode. Special functions for the control of underfloor heating, radiant floors in cooling mode and temperature compensation functions. Timer and RTC clock for day and night operation
- Display in degrees Celsius/Fahrenheit
- Serial option for remote control by supervisor.

1.1 Models available

CLIMA controllers

The clima controller is available in various hardware models, which correspond to different possible combinations and operating modes. The following tables describe the possible operating modes for the various hardware models and the specific features of each model.

The various operating modes can be selected using the dipswitches at the rear of the instrument, as explained in chapter 4 "Configuring the operating modes".

| Possible operating mode | ADCA000110 ADCA000100 | ADCD000110 ADCD000100 | ADCA000210 ADCA000410 | ADCF000210 ADCF000410 | ADCF000610 | |
|-----------------------------|--------------------------|--------------------------|--------------------------|--------------------------|------------|--|
| T | √ | √ | √ | √ | | Basic temperature control only with one relay only (R2). The analogue output is associated with the temperature.. |
| T2 | | | √ | √ | | Two-stage temperature control only, with two relays (R1 and R2). The analogue output is associated with the temperature. |
| T2A | | | √ | √ | | Two-stage temperature control only, with two relays (R1 and R2) and automatic control of cooling/heating mode. The analogue output is associated with the temperature. Other settings for this mode are available by parameter. See the chapter on "Functions". |
| H | | √ | | √ | | Basic humidity control only with one relay only (R2) associated with humidification or dehumidification control. The analogue output is associated with the humidity. |
| T+H | | | | √ | | Temperature and humidity control. One relay is associated with the temperature (R1), the other (R2) associated with humidification or dehumidification control. Analogue output associated with the humidity. |
| T2+H | | | | √ | | Two-stage temperature and proportional humidity control. The two relays are associated with the temperature (R1 and R2), the analogue output is associated with the humidity. |
| T2A+H | | | | √ | | Two-stage temperature and proportional humidity control with automatic control of the cooling/heating mode. The two relays (R1 and R2) are associated with the temperature, the analogue output is associated with the humidity. Other settings for this mode are available by parameter. See the chapter on "Functions" |
| T+H radiant ON/ OFF | √ | √ | √ | √ | √ | Model for radiant systems, with ON/OFF control. Temperature control only or temperature and humidity control, according to the model purchased. If humidity control is available, the analogue output is associated with this. |
| T+H radiant proportional | | | | | √ | Model for radiant systems, with proportional control. Temperature and humidity control. |

Tab. 1.a

Table of hardware codes:

| Purchase code | Hardware features | Functions performed |
|---|--|--|
| ADCA000100 Standard thermostat | 2 AI temperature: instrument, remote opt. 1 DO: relay output (R2) 1 DI: voltage-free contact 1 AO: 0/10 V voltage | Performs temperature control only in manual mode. Based on the set parameters, the thresholds for the activation of the relays and the analogue output are selected, according to the temperature measured by the instrument or the remote temperature sensor. |
| ADCA000110 Thermostat standard with RTC | 2 AI temperature: instrument, remote opt. 1 DO: relay output (R2) 1 DI: voltage-free contact 1 AO: 0/10 V voltage 1 clock with backup | As for the previous model, however as this model comes with an internal clock, operation with time bands can also be set, 2 bands a day, the same for all 7 days of the week. In the event of power failures, the time is stored for a maximum of 2 days. |
| ADCA000210 Advanced thermostat with RTC | 2 AI temperature: instrument, remote opt. 2 DO: relay outputs (R1 & R2) 1 DI: voltage-free contact 1 AO: 0/10 V voltage 1 clock with backup | Performs temperature control only in manual or automatic mode with time bands. Based on the set parameters, the thresholds for the activation of the relays and the analogue output are selected, according to the temperature measured by the instrument. This model has an internal clock and operation with time bands can be set, 2 bands a day, the same for all 7 days of the week. In the event of power failures the time is stored for a maximum of 2 days. |
| ADCA000410 Advanced thermostat with RTC & optically-isolated DI | 2 AI temperature: instrument, remote opt. 2 DO: relay output (R1 & R2) 1 DI: optically isolated 1 AO: 0/10 V voltage 1 clock with backup | As for the previous model, but with 24 V optically-isolated digital input. |
| ADCD000100 Standard humidistat | 2 AI temperature: instrument, remote opt. 1 Humidity sensor 1 DO: relay output (R2) 1 DI: voltage-free contact 1 AO: 0/10 V voltage | Performs temperature or humidity control in manual mode according to the operating mode selected. If the T operating modes are selected, the humidity sensor is used for display only, and vice-versa if selecting H mode. |
| ADCD000110 Standard humidistat with RTC | 2 AI temperature: instrument, remote opt. 1 Humidity sensor 1 DO: relay output (R2) 1 DI: voltage-free contact 1 AO: 0/10 V voltage 1 clock with backup | As for the previous model, however as this model comes with an internal clock, operation with time bands can also be set, 2 bands a day, the same for all 7 days of the week. In the event of power failures, the time is stored for a maximum of 2 days. |
| ADCF000210 Advanced thermostat/humidistat with RTC | 2 AI temperature: instrument, remote opt. 1 Humidity sensor 2 DO: relay outputs (R1 & R2) 1 DI: voltage-free contact 1 AO: 0/10 V voltage 1 clock with backup | Performs temperature and humidity control in manual or automatic mode with time bands. Based on the set parameters, the thresholds for the activation of the relays and the analogue output are selected, according to the temperature measured by the instrument. This model has an internal clock and operation with time bands can be set, 2 bands a day, the same for all 7 days of the week. In the event of power failures the time is stored for a maximum of 2 days. |
| ADCF000410 Advanced thermostat/humidistat with RTC & optically-isolated DI | 2 AI temperature: instrument, remote opt. 1 Humidity sensor 2 DO: relay outputs (R1 & R2) 1 DI: optically isolated 1 AO: 0/10 V voltage 1 clock with backup | As for the previous model, but with 24 V optically-isolated digital input. |
| ADCF000610 Advanced thermostat/humidistat for radiant applications | 2 AI temperature: instrument, remote opt. 1 Humidity sensor 2 DO: relay outputs (R1 & R2) 1 DI: optically isolated 1 AO: 0/10 V voltage 1 clock with backup | Performs proportional control using a temperature modulating valve in radiant systems (floor, ceiling,...). The built-in sensor is used to control the room temperature and the remote sensor to control the water outlet temperature. Relay (R2) is dedicated to humidity control, relay (R1) is dedicated to ON/OFF room temperature control. |

Tab. 1.b

Options for CLIMA (to be ordered separately)

| Purchase code | Functions performed |
|---------------|--|
| ADCF006500 | Remote temperature-humidity sensor in the version for duct applications. Includes 3 metre connection cable. Note: The remote temperature-humidity sensor must be used as an alternative to the built-in temperature-humidity sensor. Use specific HW models (ADCA***) or remove the built-in sensor, as explained in the paragraph "Remote temperature/humidity sensor" (page 17). |
| IROPZ48500 | Adapter for the RS485 serial connection, used to connect the controller to a supervisory network (CAREL or Modbus® protocol) |
| IROPZKEY00 | Key with battery for copying the parameters (Up-DownLoad), used to duplicate the Setup Parameters for all eight models (selected by dipswitch) with specific values for each model. |
| IROPZKEYA0 | Key with power supply (from mains) for copying the parameters (Up-DownLoad). |

Tab. 1.c

2. INSTALLATION

Below is a description of the recommended operations for correct installation.

2.1 Assembly

Open the product by detaching the front part from the mounting base, as shown in Fig. 2.a:

- Using a screwdriver, remove the screw holding the tab in the opening.
- Once having removed the screw, slide the plastic tab as shown in the figure so as to remove it from the instrument and be able to lever the catch.
- To open the instrument, press the tab on the front by inserting a flat-head screwdriver into the slit in the middle on the bottom of the case and at the same time flip the front panel upwards.

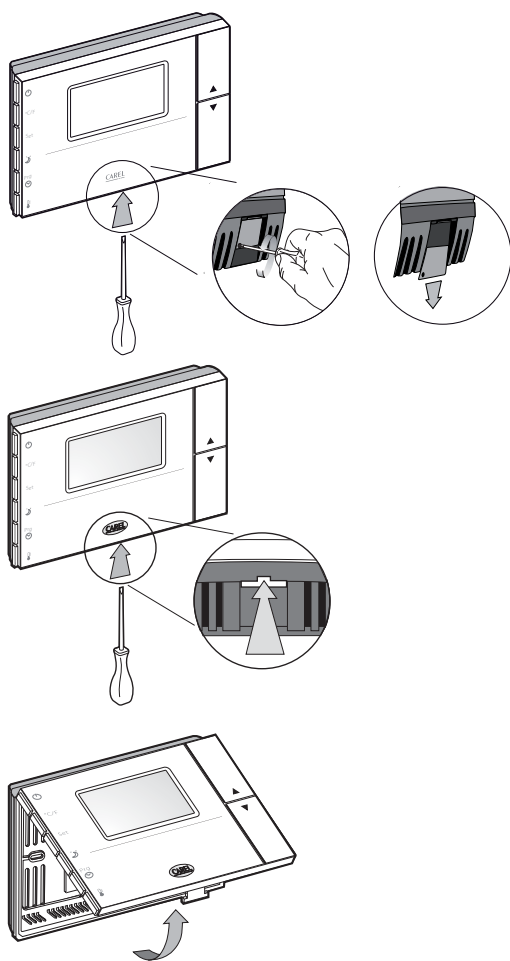

Fig. 2.a

- Once having completely removed the cover of the instrument, the two parts remain connected by a flat cable that can be disconnected from the front panel.
- Fasten the bottom of the clima to the wall using the screws contained in the packaging.
- To connect the wires to the terminal block, remove the terminal covers by squeezing the two fins.
- Make the required connections according to the model chosen, running the connection cables through the hole in the middle of the bottom shell and connecting them to the terminal block, observing the indications on the label. Separate the connection and control cables from the relay cables. The wiring diagrams are shown in paragraph 2.3.

Important: Make sure all the power supply lines have been connected, both low voltage (24 Vac/dc) and, where necessary, high voltage for the relays (230 V), before reconnecting the front part of the instrument using Front-Rear flat cable.

Note: For the purposes of electrical safety (EN60730-1), once the controller has been installed, tighten the plastic tab in the housing for opening the instrument.

Accessories and dipo switches (Fig. 2.b)

| Connector | Function |
|-----------------|---|
| J1 | - Supervisor serial connection using code IROPZ48500. - Key connector for copying the parameters. The serial connection, if used, must be momentarily disconnected.. |
| J2 | Used to connect the remote temperature and humidity sensor ADCF006500. Also use the centre screw for the lug connected to the cable shield. |
| FLAT Front-rear | The flat front/rear connection cable must be reconnected in the position defined by the plastic part to ensure correct polarity |
| Dipswitches | For configuring operation and cooling/heating, humidification/dehumidification modes |

Tab. 2.a

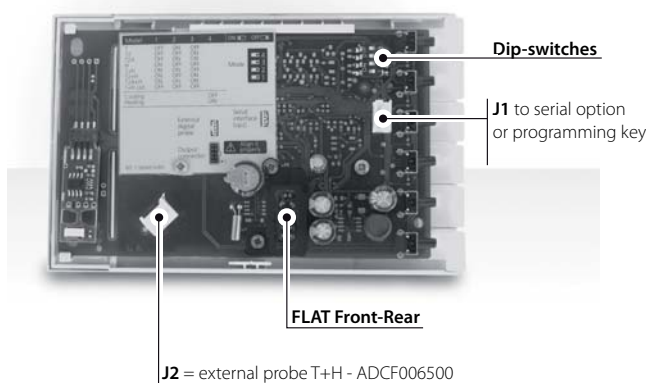

Fig. 2.b

2.2 Dimensions

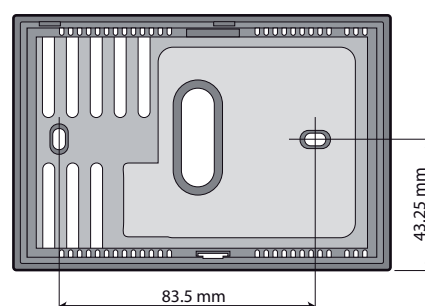
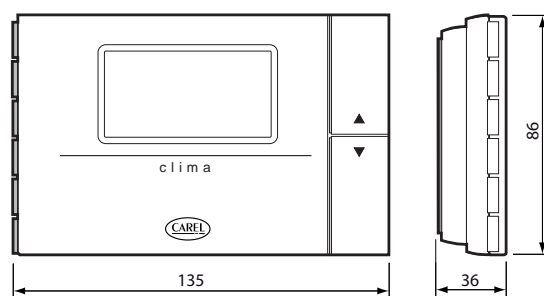
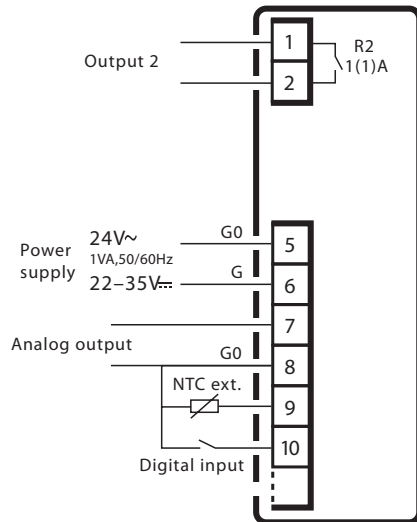

Fig. 2.c

2.3 Electrical connections:



Models with one relay only and voltage-free digital input:

| Code | Description |
|------------|---------------------|
| ADCA000100 | temperature control |
| ADCA000110 | temperature control |
| ADCD000100 | humidity control |
| ADCD000110 | humidity control |

Tab. 2.b

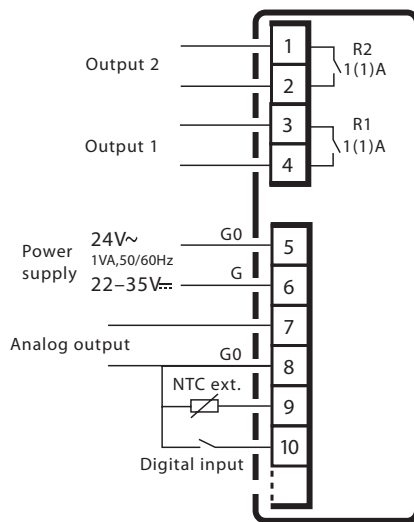

Models with two relays and voltage-free digital input:

| Code | Description |
|------------|--------------------------------|
| ADCA000210 | temperature control |
| ADCF000210 | temperature & humidity control |

Tab. 2.c

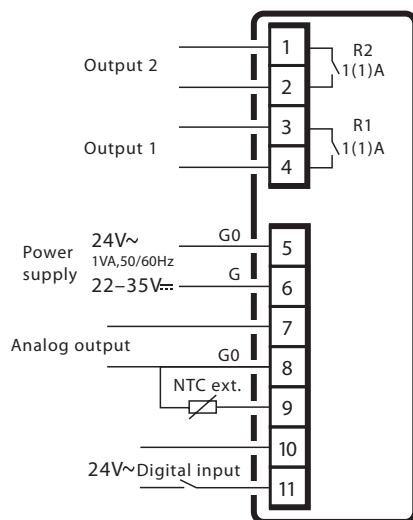

Models with two relays and optically-isolated digital input:

| Code | Description |
|------------|--|
| ADCA000410 | temperature control |
| ADCF000410 | temperature & humidity control |
| ADCF000610 | Temperature & humidity control of radiant floors, proportional mode relay 2: used for humidity relay 1: used for temperature AO: analogue output for water mixing valve control remote NTC for water temperature (floor) |

Tab. 2.d

Fig. 2.d

3. USER INTERFACE AND MODES

3.1 Display and buttons

The figures below show the display and the representation of the corresponding symbols

side programming buttons

LCD display

immediately change the current set point

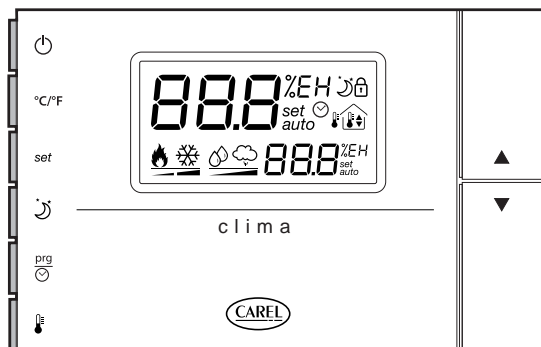

Fig. 3.a

Description of the display

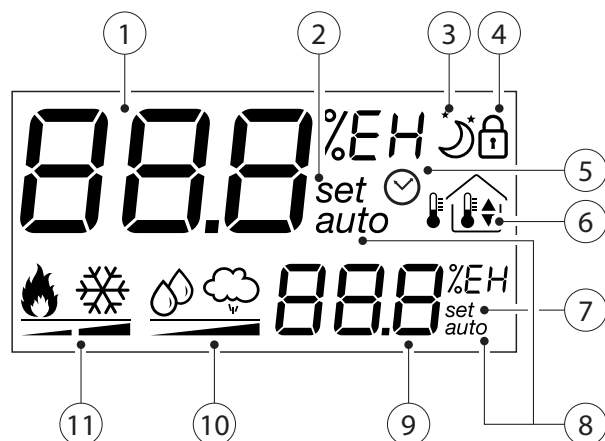

Fig. 3.b

Key:

1. LARGE field - Displays the temperature/humidity;
2. Mode for setting the active value on the large display;
3. Night mode symbol. If off = daytime mode;
4. Lock mode. The parameter is not accessible;
5. Active time bands;
6. Outside/inside/maximum/minimum temperature symbol;
7. Mode for setting the active value on the small display;
8. Auto operating mode;
9. SMALL field - Displays the temperature/humidity;
10. Dehum. () /humid. () operation. When the ramp symbol is on the corresponding mode is active;
11. Heating () /cooling () operation. When the ramp symbol is on the corresponding mode is active. In the clima models with 2 relays, the 2 segments come on independently. In the clima models with 1 relay the 2 segments are either both on or off.

3.2 Description of the buttons

| Button | Meaning |
|-------------------------------------|--|
| | CLIMA controller On/Off. If the remote ON/OFF digital input is connected, the function of the button may be disabled. |
| $^{\circ}\text{C}/^{\circ}\text{F}$ | Selects the temperature display mode, degrees Celsius or Fahrenheit. Whenever pressed switches the temperature units.. |
| set | Used to display and where necessary change, using the UP and DOWN buttons, the set point displayed in the SMALL field. If held for more than 5 sec accesses the parameters menu. To scroll the various parameters use UP and DOWN. To edit them press the SET button a second time and to exit the parameters menu press the PRG button. Access to the parameters is protected by password if parameter PS is enabled. |
| | Change mode manually: activates the opposite function (and the corresponding set point) to the current (night if day or day if night), for the set time. To change or reset the timer use the UP and DOWN buttons to increase or decrease the time. Press a second time to exit and return to the main menu. If sleep mode is already active, pressing the button shows the time remaining on the timer. |
| | E.g.: if the clima is in Night mode (moon symbol on) from time band, pressing this button activates daytime mode (moon symbol off) for the set time. Accesses the menu for setting the clock, the time bands, and the default value of the timer. When first pressed displays the current time (RTC); to display the other parameters, use the UP and DOWN arrows. To set a new value, press SET when displaying the desired parameter and change the value using the UP and DOWN buttons. Press a second time to exit and return to the main menu. |
| | Accesses the menu for displaying the temperature: current, maximum and minimum outside (from instrument power on), inside and outside. To display the various temperatures, press the button repeatedly. Their meaning is displayed in the box with the home symbol. |
| | Also displays the value of the analogue output when "Out" is shown in the SMALL field |
| | From the main menu increases the value of the set point displayed in the LARGE field. In the other menus displays the variables or the parameters, or alternatively sets the value after having pressed SET. |
| | From the main menu decreases the value of the set point displayed in the LARGE field. In the other menus displays the variables or the parameters, or alternatively sets the value after having pressed SET |

Tab. 3.a

The values displayed in the LARGE and SMALL fields (Fig. 3.b) depend on the setting of parameter dyS, as shown in the following table:

| dyS temperature only | LARGE FIELD | SMALL FIELD | Valid for control: |
|------------------------------|-----------------------|-----------------------|-------------------------------|
| 1 | temperature | temperature set point | T, T2, T2A |
| 2 | temperature set point | temperature | |
| 3 | temperature set point | | |
| 4 | temperature | | |
| dyS humidity only | LARGE FIELD | SMALL FIELD | Valid for control: |
| 1 | humidity | humidity set point | H |
| 2 | humidity set point | humidity | |
| 3 | humidity set point | | |
| 4 | humidity | | |
| dyS temperature and humidity | LARGE FIELD | SMALL FIELD | Valid for control: |
| 1 | humidity | temperature | T+H, T2+H, T2A+H, T+H radiant |
| 2 | temperature | humidity | |
| 3 | temperature set point | humidity set point | |
| 4 | humidity set point | temperature set point | |

Tab. 3.b

Configurations for displaying temperature and humidity.

4. CONFIGURATIONS

4.1 Configuring the operating modes

Before closing the instrument again, the chosen model must be configured.

See the table of settings allowed for the possible configurations according to the model purchased.



Important: The configurations not allowed for the specific hardware can be selected, yet obviously should be avoided, as not all the operations are available; the installer is responsible for checking that this will not cause operating problems in the installation. See the chapter on "Functions" for a detailed description of each individual operating mode.

Settings allowed for each model

| Dip1 | Dip2 | Dip3 | Model | ADCA000100 | ADCA000110 | ADCD000100 | ADCD000110 | ADCA000210 | ADCA000410 | ADCF000210 | ADCF000410 | ADCF000610 | |
|--|------|------|-----------------------------|--------------|--------------|--------------|--------------|--------------|--------------|------------|------------|------------|--|
| | | | | √ | √ | √ | √ | √ | √ | √ | √ | | |
| OFF | ON | OFF | T | √ | √ | √ | √ | | | | | | Basic temperature control only with one relay only (R2). The analogue output is associated with the temperature.. |
| OFF | OFF | ON | T2 | | | | | √ | √ | | | | Two-stage temperature control only, with two relays (R1 and R2). The analogue output is associated with the temperature. |
| OFF | ON | ON | T2A | | | | | √ | √ | | | | Two-stage temperature control only, with two relays (R1 and R2) and automatic control of cooling/heating mode. The analogue output is associated with the temperature. Other settings for this mode are available by parameter. See the chapter on "Functions". |
| ON | OFF | OFF | H | | | √ | | | | √ | | | Basic humidity control only with one relay only (R2) associated with humidification or dehumidification control. The analogue output is associated with the humidity. |
| ON | ON | OFF | T+H | | | | | | | √ | | | Temperature and humidity control. One relay is associated with the temperature (R1), the other (R2) associated with humidification or dehumidification control. Analogue output associated with the humidity. |
| ON | OFF | ON | T2+H | | | | | | | √ | | | Two-stage temperature and proportional humidity control. The two relays are associated with the temperature (R1 and R2), the analogue output is associated with the humidity. |
| ON | ON | ON | T2A+H | | | | | | | √ | | | Two-stage temperature and proportional humidity control with automatic control of the cooling/heating mode. The two relays (R1 and R2) are associated with the temperature, the analogue output is associated with the humidity. Other settings for this mode are available by parameter. See the chapter on "Functions" |
| OFF | OFF | OFF | T+H radiant ON/OFF | output R2 | output R2 | output R1 | output R1 | output R1 | output R1 | | | | Model for radiant systems, with ON/OFF control. Temperature control only or temperature and humidity control, according to the model purchased. If humidity control is available, the analogue output is associated with this. |
| Based on radiant model selected (see tab. 4.q) | | | T+H radiant proportional | | | | | | | √ | | | Model for radiant systems, with proportional control. Temperature and humidity control. |

Tab. 4.a

Dipswitch configurations

The 4 dipswitches are used to set the instrument for the required control mode.

| | |
|-------------|-------------------------------------|
| Dip 1, 2, 3 | Control mode as per the above table |
| Dip 4 | OFF – cooling/dehumidification |
| | ON – heating/humidification |

Tab. 4.b

The activation outputs (relays) are assigned to temperature and humidity control as per the table below:

| Relay 1 | Relay 2 | Model |
|-------------|-------------|----------------------------|
| - | temperature | T |
| temperature | temperature | T2, T2A |
| - | humidity | H |
| temperature | humidity | T+H, T2+H, T2A+H, T+H rad. |

Tab. 4.c

The activation outputs (relays) are assigned to temperature and humidity control as per the table below:

Table of manufacturer default settings

| Purchase code | Control set | Dip1 | Dip2 | Dip3 | Dip4 | Model |
|--------------------------|---------------|------|------|------|------|--|
| ADCA000100 ADCA000110 | T | OFF | ON | OFF | OFF | Basic temperature control only with one relay only. Analogue output associated with the temperature. |
| ADCA000210 ADCA000410 | T2A | OFF | ON | ON | OFF | Two-stage temperature control only, automatic cooling/heating, with 2 relays. The analogue output can be configured for cooling or heating.. |
| ADCD000100 ADCD000110 | H | ON | OFF | OFF | ON | Basic humidity control with one relay only. Analogue output associated with the humidity. |
| ADCF000210 ADCF000410 | T2A+H | ON | ON | ON | ON | Two-stage temperature and humidity control, automatic cooling/heating with 2 relays associated with the temperature. Analogue output associated with the humidity. |
| ADCF000610 | radiant prop. | OFF | ON | OFF | ON | T+H control for radiant systems, proportional control model. |

Tab. 4.d

4.2 Main parameters to be set

The parameters for each operating mode also feature a default value, and these values can be restored by running the "Factory set" operation. The default values are the same for all eight modes. See the table of parameters for details of the default values and settings.

Initially at least the following parameters need to be checked/set:

- **SET POINT:** depending on the operating mode, different set points are used. To set these, access (SET button – 5 seconds) the mode for setting the parameters and set the corresponding values. For the current mode only, the value can be accessed directly using UP, DOWN or set, UP, DOWN (for the SMALL field). The following set points need to be defined:
 - set point for temperature control
 - Daytime (def. 20.0 °C) and night set point (def. 18.0 °C) in heating
 - Daytime (def. 24.0 °C) and night set point (def. 26.0 °C) in cooling
 - set point for humidity control
 - Humidification set point (def. 30.0 % RH)
 - Dehumidification set point (def. 70.0 % RH)
- **Clock, TIME BANDS Prg/  (clock):** Press the corresponding button to display and if necessary set the default duration of the change mode timer, display or set the RTC clock and set the Day and Night time bands.

| rtC | clock hh:mm | |
|-----|----------------------------|--------------|
| SLP | manual changeover duration | def. 8 hours |
| dAy | start day band | def. 08:00 |
| nlt | start night band | def. 20:00 |

Once having displayed the desired parameter using the UP/DOWN buttons, press SET and the parameter starts flashing. Edit the value using the UP/DOWN buttons and then press SET. To exit the menu, press the PRG button again. To disable the time bands function, set parameter rtC off:

- Select parameter rtC using PRG/CLOCK and set the value using the DOWN button
- When reaching 00:00 using the DOWN button the function will be off.

When parameter rtC is set to off the operating mode is always daytime, and consequently only the daytime set points are used, the night settings are only used when the NIGHT button is pressed, manually changing mode.

The same is true for models without the RTC function.

When the time bands are set, the CLOCK symbol is shown on the display.

- **PARAMETERS:** check/set the other parameters (dIF, dS1,...) based on the mode used.

The controller is then ready for operation:

- Start control by pressing the ON button (or activating the digital input, if featured).



Note: The values of the parameters are specific for each individual operating mode (T, T2, T2A,...), the user can therefore define a different set of parameters for each of the 8 control modes. The specific set of parameters will be loaded by the clima when changing the configuration of the dipswitches.

4.3 Additional functions

The controller, as well as the control algorithms for the various types of applications (air-conditioners, boilers, heat pumps, condensing units,...), features a series of additional functions, as described below.

Change night/day mode manually (NIGHT)

This activates the opposite function to the current (night if day or day if night), for the set time.

Pressing the NIGHT button once accesses the timer menu and displays the duration.

To change the duration of the temporary mode use the UP/DOWN buttons.

To change the value of the timer permanently, access the Prg menu and set parameter SLP.

To set the current timer to zero and return the instrument to the original mode, press the NIGHT button, the remaining time is displayed, then press DOWN until reaching the value 0. The instrument, after having briefly displayed the message OFF SLP, automatically returns to the main menu. Once having set the timer, pressing the NIGHT button displays the time remaining on the timer. This value can be changed at any time.

To exit the menu press the NIGHT button again.

Example of operation with time bands:

RTC: fitted and configured, the time is 15:55, the symbol is on

dAy: 8:00

nlt: 16:00

At 16:00 the controller will switch to Night mode with a lower (in heating) or higher (in cooling) temperature setting. Assuming the user wants to extend Day mode for a further 3 hours, having to work late in the office.

The following operations are required:

- press the NIGHT button;
- set the timer to 3h and 00' using the DOWN button;
- press the NIGHT button to confirm the setting.

The clima returns to Day mode with the corresponding set point. It will automatically return to Night mode according to the time bands when the timer reaches zero.

Functions that can be associated with the digital input

According to the model chosen, the digital input can be connected to:

- a voltage-free ON/OFF contact;
- a 24 Vac voltage signal with optically-isolated reference.

The digital input can be used for the functions listed in the table and these are selected by setting parameter dl from the parameters menu. Parameter POL is used to define the polarity of the contact.

The digital input has priority over all other settings (keypad, supervisor)



| code | description of the parameter | range | def. | UOM |
|------|---|--------|------|-----|
| dl | Digital input configuration OFF: disabled 1: select remote cooling/heating 2: remote ON/OFF 3: select day/night (alternative set point) 4: remote alarm | OFF-4 | OFF | - |
| POL | Digital contact polarity Used to choose whether to consider the digital input active when closed or open or alternatively whether or not there is voltage in the optically-isolated version. Voltage-free contact: nE: active when the input is closed PO: active when the input is open Optically isolated: nE: active when voltage is present at the input PO: active when voltage is not present at the input | nE, PO | nE | - |

Tab. 4.e

Sensor calibration

To make up for any errors due to the length of the cables or the sensors connected, the controller features two parameters for calibrating the values read by the sensors.

The following parameters are involved:

| code | description of the parameter | range | def. | UOM |
|--|--|-----------|------|------|
| CAL+ Int  | Inside temperature calibration, digital sensor or NTC Within a maximum of ± 10 °C | -10 to 10 | 0.0 | °C |
| CAL+ Est  | Outside temperature calibration, NTC sensor Within a maximum of ± 10 °C | -10 to 10 | 0.0 | °C |
| CAL+HUn  | Digital humidity sensor calibration. Within a maximum of ± 15 rH | -15 to 15 | 0.0 | % rH |

Tab. 4.f

AUTO humidity control

In addition to the modes featured by the control algorithms, the humidity can be controlled automatically, based on the reading of the outside temperature sensor. The aim of this type of control is to simplify the setting of the clima, changing the humidity control according to the outside environmental conditions and therefore maximise the comfort of the user when moving into/out of the air-conditioned environment.

This operating mode is selected by setting parameter AUT.

According to the level set using the up/down buttons, with a value from 1H to 7H, a different humidity set point trend is defined.

To disable this operating mode, in the parameters menu set the value of Aut = 0.



AUTO mode for the humidification control is only possible if the outside temperature sensor is installed.

| code | description of the parameter | range | def. | UOM |
|---|---|-----------------|------|-----|
| AUT  | Humidity set point level compensated according to the outside temperature If humidity control is featured, the ambient humidity is controlled with an automatic set point, defined from 1H to 7H using the buttons, as specified in Table 4.g. If set to OFF, the mode is disabled. Setting one of the levels shown in the table, the controller independently sets a humidity set point in relation to the outside temperature measurement. | OFF 1H to 7H | OFF | - |

Table: humidity set point according to the setting of AUT (outside temperature in degrees °C)

| Level | Below: -23 °C | -23 °C to -17 °C | -17 °C to -12 °C | -12 °C to -6 °C | -6 °C to -1 °C | -1 °C to 4 °C | 4 °C to 10 °C | Above: 10 °C |
|-------|---------------|------------------|------------------|-----------------|----------------|---------------|---------------|--------------|
| 1 | 10% | 10% | 10% | 10% | 15% | 20% | 25% | 30% |
| 2 | 10% | 10% | 10% | 15% | 20% | 25% | 30% | 35% |
| 3 | 10% | 10% | 15% | 20% | 25% | 30% | 35% | 40% |
| 4 | 10% | 15% | 20% | 25% | 30% | 35% | 40% | 45% |
| 5 | 10% | 20% | 25% | 30% | 35% | 40% | 45% | 45% |
| 6 | 10% | 25% | 30% | 35% | 40% | 45% | 45% | 45% |
| 7 | 10% | 30% | 35% | 40% | 45% | 45% | 45% | 45% |

Tab. 4.g

Average of the temperature readings between the built-in sensor and the remote sensor

This operating mode is only possible if the remote sensor is installed, otherwise the instrument shows a remote sensor error and only uses the built-in sensor for control.

The average value is both used for control and shown on the display. This temperature control mode is based not only on the reading of the built-in sensor (TI), but also the outside temperature sensor (TE). It is in

essence a weighted average of the two temperature measurements according to the above mentioned formula:

$$T_m = (T_I * (100 - nEd) + T_E * nEd) / 100 \quad \text{Def.}=0 \quad (\text{built-in sensor only})$$

| code | description of the parameter | range | def. | UOM |
|------|---|----------|------|-----|
| nEd | Parameter for control with average value sensor values Defines the average control temperature (Tm), based on the weighted average of the inside temperature (TI) and outside temperature (TE). Both the measurements must be valid and Tm is achieved with the following formula: Tm = (TI * (100 - nEd) + TE * nEd) / 100 Def=0 internal probe only | 0 to 100 | 0.0 | % |

Tab. 4.h

RS485 serial communication protocol

The controller features serial communication to the supervisor using CAREL protocol V3.0 and higher and the Modbus® RTU protocol. To connect to the supervisor over RS485, option IROPZ48500 is required.

The transmission speed and communication protocol settings are shown in the table:

| code | description of the parameter | range | def. | UOM |
|------|---|--------|------|-----|
| SEr | Select serial communication protocol 0: CAREL protocol 9.6 kb/s 1: CAREL protocol 19.2 kb/s 2: Modbus® 9.6 kb/s, even parity, 8 bits, 1 stop 3: Modbus® 19.2 kb/s, even parity, 8 bits, 1 stop 4: Modbus® 9.6 kb/s, no parity, 8 bits, 2 stop 5: Modbus® 19.2 kb/s, no parity, 8 bits, 2 stop | 0 to 5 | 1 | - |

Tab. 4.i

Temperature set point compensation based on the outside temperature

For control that considers the outside temperature, the outside temperature sensor can be connected to compensate the temperature set point. Such compensation, once activated, is the same for all control modes, day, night, cooling and heating.

Parameters Cts and Ctt define the difference between the set point and the outside temperature above which compensation is activated. Parameter CSt defines the compensation factor and CdF the maximum set point compensation allowed.

Cooling control: $SP \text{ comp.} = \text{setpoint} + (\text{Text} - \text{set point} - Cts) * CSt$

Heating control: $SP \text{ comp.} = \text{setpoint} - (\text{set point} - \text{Text} - Ctt) * CSt$

The maximum correction value is limited by parameter CdF, that is, if the compensation calculated is higher (cooling) or lower (heating) than CdF, the controller uses ± CdF as the maximum compensation value.

The weight of the correction is defined by CSt, set in tenths of °C from -1 to +1.

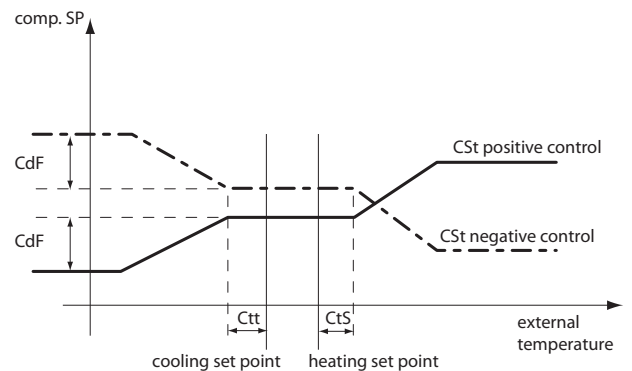

Fig. 4.j

| code | description of the parameter | range | def. | UOM |
|------|---|---------|------|-----|
| CSt | Parameter CSt enables and sets the gain for set point compensation according to the outside temperature. If CSt = 0 compensation is disabled. Also see parameters Ctt and Cts. | -1 to 1 | 0.0 | °C |
| CdF | The maximum value for the compensated set point is limited by this parameter. In heating mode, if the difference calculated for set point compensation is higher than CdF, the instrument uses CdF as the maximum difference from the set point. Similarly, in cooling mode if the difference calculated for set point compensation is less than CdF, the instrument uses CdF as the maximum difference from the set point. | 0 to 20 | 2.0 | °C |
| Ctt | Temperature set point compensation in heating based on the outside temperature measurement: compensated set point = set point - (set point - Text - Ctt) * CSt Compensation is activated only if: Text < set point - Ctt | 0 to 25 | 10.0 | °C |
| Cts | Temperature set point compensation in cooling based on the outside temperature measurement: compensated set point = set point + (Text - set point - Cts) * CSt Compensation is activated only if: Text > set point + Cts | 0 to 25 | 10.0 | °C |

Tab. 4.j

Control the outputs via RS485 serial connection

The status of the analogue output and the relays on the instrument can be controlled via a serial connection to a supervisor.

The variables are read only if LIn=no, or read/write if LIn=yES
The variables are described in the table of supervisor variables and must be used according to the current mode (T, T2, T2A,...), the status on the LCD automatically shows the outputs.

Important: This function, if enabled, completely replaces the control performed by the instrument. In this operating mode, together with the outputs, the symbols displaying the operating status of the instrument are also activated according to the current mode.

Note: If the instrument is not queried for more than two minutes, "override" mode is disabled:



- all the outputs are disabled;
- the no link error (ELn) is signalled on the display

| code | description of the parameter | range | def. | UOM |
|------|--|---------|------|-----|
| LIn | Enabling this parameter allows the outputs to be controlled directly via the serial connection. no: The function is disabled. yES: The function is enabled. | no, yES | no | - |

Tab. 4.k

Control cooling/heating mode via RS485 serial connection

This function allows the operating mode, cooling/heating, to be selected by parameter (including via serial connection), rather than on the dipswitches. If the function is enabled, the dipswitch setting is ignored and the operating mode is defined using parameter EI.

| code | description of the parameter | range | def. | UOM |
|---|--|---------|------|-----|
| EI  | Control cooling/heating operating mode Enables the possibility to define the operating mode, cooling/heating, by parameter rather than by DIP 4. dIS: Parameter EI is disabled, cooling/heating mode is selected by DIP 4 on the rear. En: Parameter EI is enabled, cooling/heating mode is selected by parameter EI. | dIS, En | dIS | - |
| EI  | Programming operation cooling heating Select cooling/heating operation Selects the mode, cooling or heating. This parameter is only active if this mode is enabled by the previous parameter. E: The instrument works in cooling mode I: The instrument works in heating mode | E, I | E | - |

Tab. 4.l

Remote temperature/humidity sensor

For the models without the humidity sensor already installed, a remote sensor for ducts (temperature + humidity) can be connected, up to a maximum distance of 3 m.

The sensor is purchased separately, code ADCF006500 which includes the wired cable in the maximum available length (3 m).

The remote temperature/humidity sensor can be installed on all ADCA*** codes.

Note: The remote temperature/humidity sensor cannot be connected to controller codes ADCF*** and ADCD*** that already have a built-in humidity sensor, as this would cause the temperature and humidity measurements to freeze.

To retrofit a clima model ADCF*** or ADCD*** already installed with a remote sensor, open the controller and remove the plug-in card with the temperature/humidity sensor from the PCB, as shown in the figure.

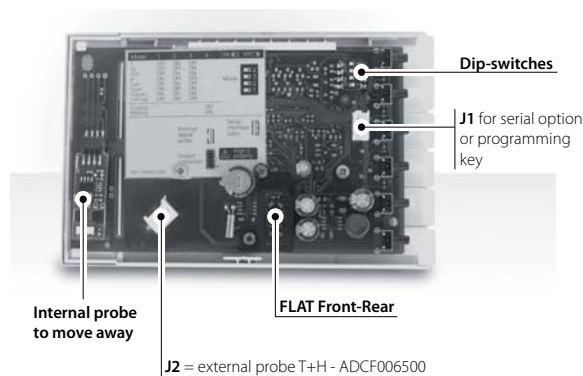

Fig. 4.k

Password

On all models a password (PS) can be set for accessing the parameters. Once the value of PS has been set (other than zero), this value must be entered in order to access the parameters.



Note: Make sure the password is kept in a safe place, as without it the parameters can no longer be accessed. The value can only be reset from the supervisor or using the parameter copying key.

| code | description of the parameter | range | def. | UOM |
|------|---|----------|------|-----|
| PS | Password for accessing the parameters Set to 0: no password is required to access the parameters. Set other than zero: the same value must be entered to access the parameters. | 0 to 999 | 0 | - |

Tab. 4.m

Antifreeze

To prevent the formation of ice and frost, the controller features the antifreeze function, which activates the relay dedicated to the temperature function regardless of the control mode, when in heating operation. Antifreeze is available in all control modes, apart from humidity only, and the corresponding relay is activated when the temperature falls below 5 °C. The function is also active when the instrument is off and is enabled 20 seconds after shutdown.

5. FUNCTIONS

This chapter describes the temperature and humidity control modes available.

The control modes for the different models of clima are based on a set of parameters, divided into two levels:

- **Level 1, basic:** main settings, always required;
- **Level 2, advanced:** used to customise the features of the controller.

Important note: Some parameters included in the advanced level, are forced to take on default values in the basic level or are linked to other parameters in the basic level.

This rule especially applies to the control differentials. In each operating mode, the links between the various basic and advanced levels are specified.

Note: Parameters with forced values are NOT visible from the supervisor:

- if level 1 is active, the level 2 parameters are not used but rather replaced by the default values or by the link value with the level 1 parameters; the supervisor can read and set the level 2 parameters that are however not effectively used for the control functions.
- the level 2 parameters are effectively used when level 2 is activated.

5.1 (T) temperature control with single output

This is used in simple applications to send a start signal to an air-conditioner or heat pump/boiler via the relay. The analogue output can be used alternately or together with the relay output to:

- control a modulating hot or cold water valve;
- as an additional proportional control step to the relay.

Dipswitch configuration:

dip1: OFF

dip2: ON

dip3: OFF

This control mode is available in both cooling and heating mode, the selection is made using dipswitch 4, or from the supervisor serial connection or digital input.

Depending on the value of LE (level), either only the basic parameters (LE=1) or all (LE=2) can be set.

LE=1

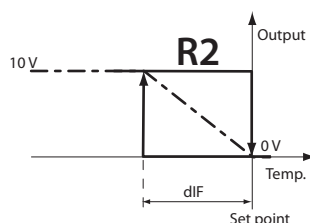

Fig. 5.a

LE=2

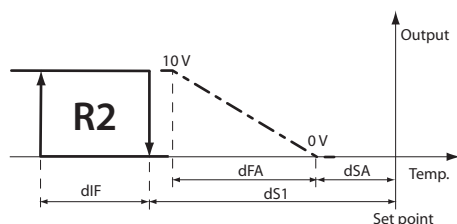

Fig. 5.b

Single-stage temperature control only in heating mode. In cooling mode the situation is diametrically opposite with reference to the set point.

Parameters involved:

| Code | Description | Default | LE | Value or link if LE = 1 |
|------|------------------------------|---------|----|-------------------------|
| ☀ | day set point in cooling | 24.0 °C | 1 | - |
| ☀🌙 | night set point in cooling | 26.0 °C | 1 | - |
| 🔥 | day set point in heating | 20.0 °C | 1 | - |
| 🔥🌙 | night set point in heating | 18.0 °C | 1 | - |
| dIF | temperature differential | 1.0 °C | 1 | - |
| dFA | analogue output differential | 1.0 °C | 2 | = dIF |
| dS1 | relay offset | 0.0 °C | 2 | = 0 |
| dSA | analogue output offset | 0.0 °C | 2 | = 0 |

Tab. 5.a

Note: When LE=1 proportional and ON/OFF control overlap, therefore modifying parameter dIF changes the differential for both.

Note: Passing to level 2 allows the two types of control, proportional and ON/OFF, to be positioned independently. Parameters dSA and dS1 can have both positive and negative values, allowing the two types of control, proportional and ON/OFF, to be set as desired.

5.2 (T2) temperature control with double output

Two-stage temperature control only used to send a start signal to an air-conditioner or heat pump/boiler with two step operation. The analogue output can be used alternately or together with the relay output to:

- control a modulating hot or cold water valve;
- as an additional proportional control step to the relay.

Dipswitch configuration:

dip1: OFF

dip2: OFF

dip3: ON

This control mode is available in both cooling and heating mode, the selection is made using dipswitch 4, or from the supervisor serial connection or digital input.

LE=1

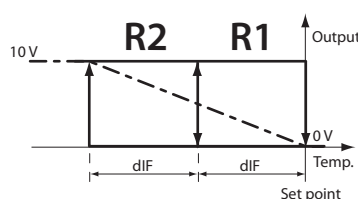

Fig. 5.c

LE=2

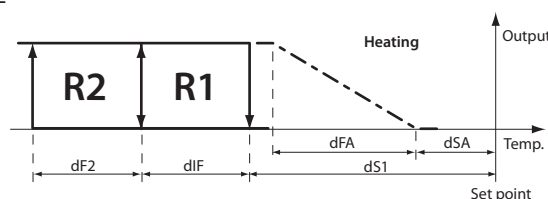

Fig. 5.d

Two-stage temperature control only in heating mode. In cooling mode the situation is diametrically opposite with reference to the set point.

Parameters involved:

| Code | Description | Default | LE | Value or link if LE = 1 |
|------|------------------------------|---------|----|-------------------------|
| | day set point in cooling | 24.0 °C | 1 | - |
| | night set point in cooling | 26.0 °C | 1 | - |
| | day set point in heating | 20.0 °C | 1 | - |
| | night set point in heating | 18.0 °C | 1 | - |
| dIF | relay 1 differential | 1.0 °C | 1 | - |
| dF2 | relay 2 differential | 1.0 °C | 2 | = dIF |
| dFA | analogue output differential | 1.0 °C | 2 | = 2 * dIF |
| dS1 | relay offset | 0.0 °C | 2 | = 0 |
| dSA | analogue output offset | 0.0 °C | 2 | = 0 |

Tab. 5.b

Note: When LE=1 proportional and ON/OFF control overlap, therefore modifying parameter DIF changes the differential for both.

Note: Passing to level 2 allows the two types of control, proportional and ON/OFF, to be positioned independently. Parameters dSA and dS1 can have both positive and negative values, allowing the two types of control, proportional and ON/OFF, to be set as desired.

5.3 (H) humidity control

This type of control is only possible on the models fitted with digital humidity sensor (ADCD*****, ADCF*****)
It is used in simple applications to send a start signal to a humidifier or dehumidifier.

The analogue output can only be used for humidification control.

Examples of using of the analogue output:

- for proportional humidity control by CAREL humidifiers, for example compactSteam
- as an additional step to the relay for humidity control.

Dipswitch configuration:

- dip1: ON
- dip2: OFF
- dip3: OFF

The control mode is selected using dipswitch 4 located on the rear.

- dip4 = ON for humidification
- dip4 = OFF for dehumidification

LE=1

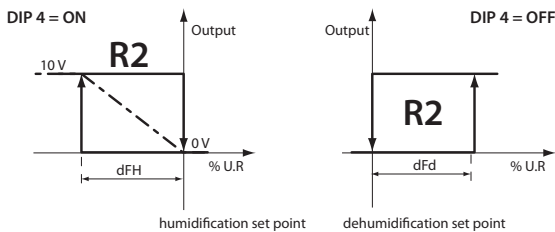

Fig. 5.e

LE=2

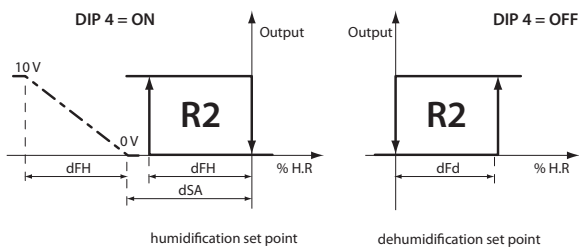

Fig. 5.f

Parameters involved:

| Code | Description | Default | LE | Value or link if LE = 1 |
|------|-------------------------------|-----------|----|-------------------------|
| | humidification set point | 50.0 % rH | 1 | - |
| | dehumidification set point | 70.0 % rH | 1 | - |
| dFH | humidification differential | 5.0 % rH | 1 | - |
| dFd | dehumidification differential | 5.0 % rH | 1 | - |
| dSA | analogue output offset | 0.0 % rH | 2 | =0 |

Tab. 5.c

5.4 (T+H) temperature and humidity control

This type of control is only possible on the models fitted with digital temperature + humidity sensor (ADCF*****)

It is used in simple applications, with one stage for the temperature and one for the humidity, to send a start signal to an air-conditioner or heat pump/boiler via the relay. The analogue output is only activated in humidification mode.

Dipswitch configuration:

- dip1: ON
- dip2: ON
- dip3: OFF

Control is available in both cooling and heating (dip4).

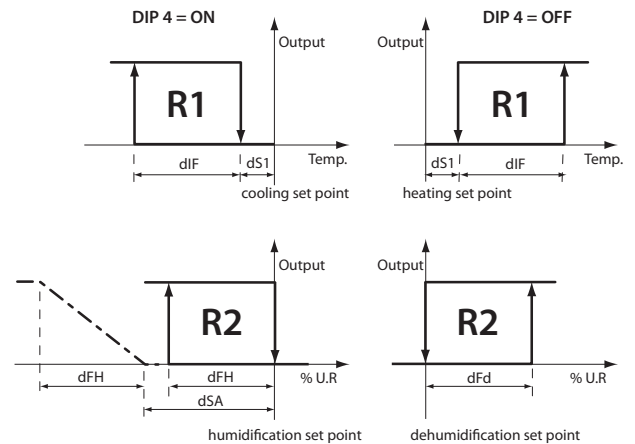

Fig. 5.g

Temperature (top) and humidity control mode (bottom) when LE=2.

Parameters involved:

| Code | Description | Default | LE | Value or link if LE = 1 |
|------|-----------------------------|-----------|----|-------------------------|
| | day set point in cooling | 24.0 °C | 1 | - |
| | night set point in cooling | 26.0 °C | 1 | - |
| | day set point in heating | 20.0 °C | 1 | - |
| | night set point in heating | 18.0 °C | 1 | - |
| dIF | relay differential | 1.0 °C | 1 | - |
| dS1 | relay offset | 0.0 °C | 2 | = 0 |
| dSA | analogue output offset | 0.0 % rH | 2 | =0 |
| | humidification set point | 50.0 % rH | 1 | - |
| | dehumidification set point | 70.0 % rH | 1 | - |
| dFH | humidification differential | 5.0 % rH | 1 | - |
| dFd | dehumidification diff. | 5.0 % rH | 1 | - |

Tab. 5.d

5.5 (T2 + H) two-stage temperature and humidity control

This is used in applications with two outputs dedicated to temperature control to send a start signal to an air-conditioner or heat pump/boiler with two steps. The analogue output is for humidification control when the controller is in heating mode. If the controller is in cooling operation, humidity control is disabled, and if attempting to change the set point the lock symbol is shown.

Dipswitch configuration:

dip1: ON
dip2: OFF
dip3: ON

Control is available in both cooling and heating (dip4).

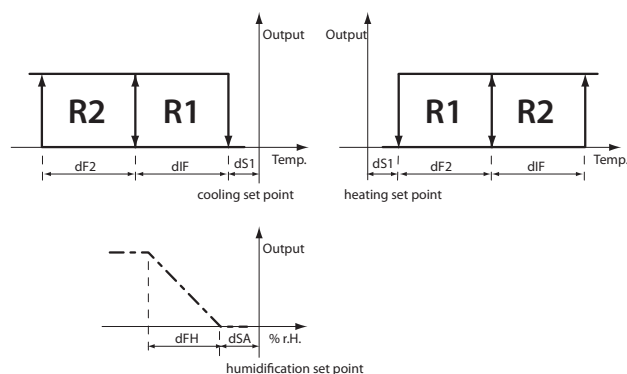

Fig. 5.h

Temperature and humidity control mode when LE=2.

Parameters involved:

| Code | Description | Default | LE | Value or link if LE = 1 |
|------|-----------------------------|-----------|----|-------------------------|
| ☀ | day set point in cooling | 24.0 °C | 1 | - |
| ☀🌙 | night set point in cooling | 26.0 °C | 1 | - |
| 🔥 | day set point in heating | 20.0 °C | 1 | - |
| 🔥🌙 | night set point in heating | 18.0 °C | 1 | - |
| dIF | relay 1 differential | 1.0 °C | 1 | - |
| dF2 | relay 2 differential | 1.0 °C | 2 | =dIF |
| dS1 | relay offset | 0.0 °C | 2 | = 0 |
| dSA | analogue output offset | 0.0 % rH | 2 | =0 |
| ☁ | humidification set point | 50.0 % rH | 1 | - |
| dFH | humidification differential | 5.0 % rH | 1 | - |

Tab. 5.e

5.6 (T2A) automatic temperature control only

This control mode is available on products with two relay outputs for temperature control (ADCA*****) and is used to have three different types of automatic cooling/heating control. Typical applications: air-conditioner plus boiler, air-conditioner/heat pump, condensing unit. Once having selected the basic configuration using the dipswitches, the three operating modes available are selected by parameter (Adc).

Dipswitch configuration:

dip1: OFF
dip2: ON
dip3: ON

Configuration 1 (AdC = 1)

For the control of a classic system with air-conditioner + boiler. The controller sends to the start signal to one or other appliance- Automatic operating mode is signalled on the display by the AUTO symbol, next to the set point.

The analogue output is defined for one function only, heating or cooling. The selection is made using dipswitch 4 located on the rear.

The figure illustrates operation:

DIP 4=ON

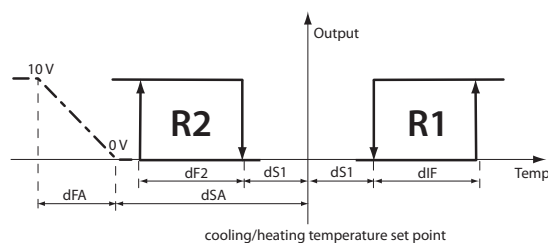

Fig. 5.i

DIP 4=OFF

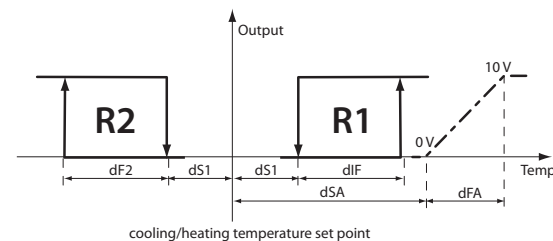

Fig. 5.j

Cooling/heating control for air-conditioner/boiler systems. The analogue output is associated with cooling or heating control, as set by DIP 4 when LE=2.

Parameters involved:

| Code | Description | Default | LE | Value or link if LE = 1 |
|------|--|---------|----|-------------------------|
| 🔥☀ | day set point (same for cooling & heating) | 20.0 °C | 1 | - |
| 🔥☀🌙 | night set point (same for cooling & heating) | 18.0 °C | 1 | - |
| dIF | relay 1 differential | 1.0 °C | 1 | - |
| dF2 | relay 2 differential | 1.0 °C | 2 | = dIF |
| dFA | analogue output differential | 1.0 °C | 2 | = dIF |
| dS1 | relay 1 & 2 offset | 0.5 °C | 1 | - |
| dSA | analogue output offset | 0.0 °C | 2 | = dS1 |

Tab. 5.f

Configuration 2 (AdC = 2) - DiP 4 has no effect

Used to control a classic system with air-conditioner/heat pump and heating/cooling call. Automatic operating mode is signalled on the display by the AUTO symbol, next to the set point.

Two set points need to be defined, one for cooling and the other for heating.

The mode switches between cooling and heating automatically according to the room temperature measured.

The two set points are set by pressing the SET button or the up or down button, first the cooling set point is displayed and then the heating set point, the controller automatically checks that there is a difference of at least 1°C between the two set points.

Relay 1 controls the heating/cooling signal. Relay 2, on the other hand, manages the changeover.

See the following graph for the description of this operating mode when LE=2.

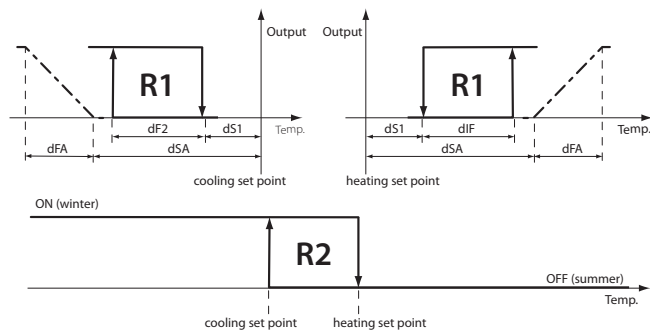

Fig. 5.k

Parameters involved:

| Code | Description | Default | LE | Value or link if LE = 1 |
|------|-------------------------------|---------|----|-------------------------|
| ☸ | day set point in cooling | 24.0 °C | 1 | - |
| ☸ 🌙 | night set point in cooling | 26.0 °C | 1 | - |
| 🔥 | day set point in heating | 20.0 °C | 1 | - |
| 🔥 🌙 | night set point in heating | 18.0 °C | 1 | - |
| dIF | relay 1 diff. in cooling mode | 1.0 °C | 1 | - |
| dF2 | relay 1 diff. in heating mode | 1.0 °C | 2 | = dIF |
| dFA | analogue output differential | 1.0 °C | 2 | = dIF |
| dS1 | relay offset | 0.5 °C | 2 | =0 |
| dSA | analogue output offset | 0.0 °C | 2 | =0 |

Tab. 5.g

Configuration 3 (AdC = 3) - DiP 4 has no effect

The typical application in this case is a condensing unit with ON/OFF control of the outlet fan and automatic changeover.

Automatic operating mode is signalled on the display by the AUTO symbol, next to the set point.

Like in the previous configuration, there are two set points, one for cooling and the other for heating, both of which can be set.

The mode switches between cooling and heating automatically according to the room temperature measured.

The two set points are set by pressing the SET button or the up or down button, first the cooling set point is displayed and then the heating set point, the controller automatically checks that there is a difference of at least 1°C between the two set points.

Relay 1 is controlled directly by the ON/OFF button on the instrument, when the instrument is off relay 1 is off, when the instrument is on the relay is always active.

Relay 2, on the other hand, manages changeover.

The analogue output is dedicated to heating/cooling control.

Relay 1 = FAN control based on the status (ON/OFF) of the clima controller.

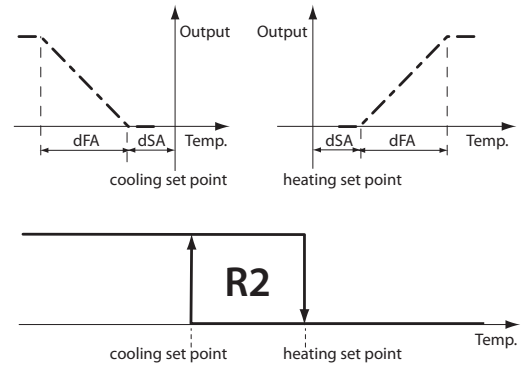

Fig. 5.l

Parameters involved:

| Code | Description | Default | LE | Value or link if LE = 1 |
|------|------------------------------|---------|----|-------------------------|
| ☸ | day set point in cooling | 24.0 °C | 1 | - |
| ☸ 🌙 | night set point in cooling | 26.0 °C | 1 | - |
| 🔥 | day set point in heating | 20.0 °C | 1 | - |
| 🔥 🌙 | night set point in heating | 18.0 °C | 1 | - |
| dFA | analogue output differential | 1.0 °C | 1 | - |
| dSA | analogue output offset | 0.0 °C | 2 | = 0 |

Tab. 5.h

5.7 (T2A + H) automatic temperature and humidity control

This operating mode can be used to perform two types of control (be selected by parameter Adc):

- automatic cooling/heating selection for systems with air-conditioner and boiler, with humidifier control
- reverse-cycle systems with heating and cooling set point and humidifier control.

Dipswitch configuration:

- dip1: ON
- dip2: ON
- dip3: ON

Configuration 1 (AdC =1) - DiP 4 has no effect

The typical application is the control of a classic system with air-conditioner + boiler and h proportional umidity control.

Dehumidification is performed using the air-conditioner, making sure that the temperature conditions are within the comfort limits.

There are two humidity set points, one for humidification and the other for dehumidification; the changeover points for automatic humidification/dehumidification operation are also defined.

There is just one temperature set point for both cooling and heating, the changeover (cooling/heating) occurs based on the activation points of the two outputs.

Dehumidification can only be activated if the humidity exceeds the dehumidification set point plus the differential dFd, and furthermore:
Temp > Set - dS1 - dF2

It is deactivated if the humidity is below the dehumidification set point and in furthermore:
Temp < Set - dS1 - dF2 - 0.5 °C

See the following graph for the description of this operating mode.

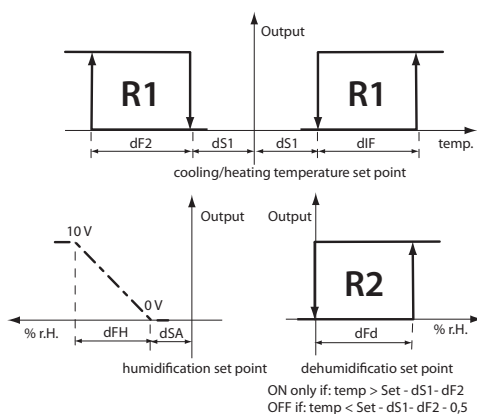

Fig. 5.m

Parameters involved:

| Code | Description | Default | LE | Value or link if LE = 1 |
|------|-------------------------------|-----------|----|-------------------------|
| - | day set point (same) | 20.0 °C | 1 | - |
| ☾ | night set point (same) | 18.0 °C | 1 | - |
| dIF | relay 1 differential | 1.0 °C | 1 | - |
| dF2 | relay 2 differential | 1.0 °C | 2 | = dIF |
| dS1 | relay offset | 0.5 °C | 1 | - |
| dSA | analogue output offset | 0 % rH | 2 | =0 |
| ☁ | humidification set point | 50.0 % rH | 1 | - |
| 💧 | dehumidification set point | 70.0 % rH | 1 | - |
| dFH | humidification differential | 5.0 % rH | 1 | - |
| dFd | dehumidification differential | 5.0 % rH | 1 | - |

Tab. 5.i

Configuration 2 (AdC = 2) - DiP 4 has no effect

For the control of a classic reverse-cycle air-conditioning system, with automatic cooling/heating changeover and proportional humidity control.

Automatic operating mode is signalled on the display by the AUTO symbol, next to the set point.

There are two set points, one for cooling and the other for heating, and both can be set.

The mode switches between cooling and heating automatically according to the room temperature measured.

The two set points are set by pressing the SET button or the UP or DOWN button, first the cooling set point is displayed and then the heating set point, the controller automatically checks that there is a difference of at least 1°C between the two set points.

Relay 1 controls the heating/cooling signal.

The analogue output controls humidification.

Relay output 2 manages the changeover in mode.

See the following graph for the description of this operating mode.

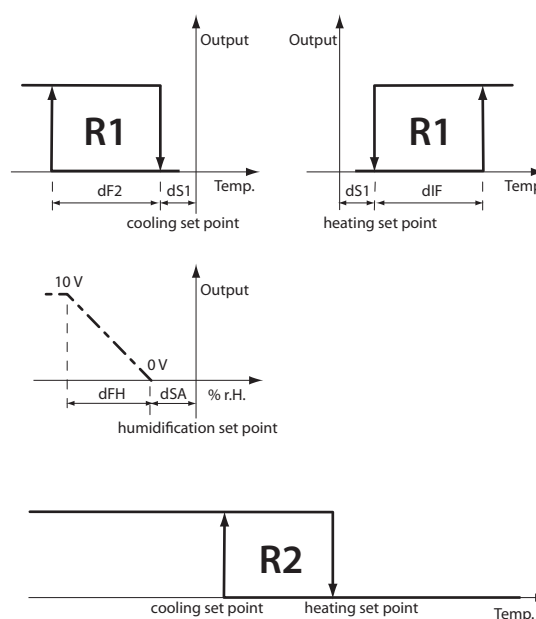

Fig. 5.n

Parameters involved:

| Code | Description | Default | LE | Value or link if LE = 1 |
|------|-------------------------------|-----------|----|-------------------------|
| ❄ | day set point in cooling | 24.0 °C | 1 | - |
| ❄ ☾ | night set point in cooling | 26.0 °C | 1 | - |
| 🔥 | day set point in heating | 20.0 °C | 1 | - |
| 🔥 ☾ | night set point in heating | 18.0 °C | 1 | - |
| dIF | relay 1 diff. in cooling mode | 1.0 °C | 1 | - |
| dF2 | relay 1 diff. in heating mode | 1.0 °C | 2 | = dIF |
| dS1 | relay 1 offset | 0.5 °C | 2 | = 0 |
| dSA | analogue output offset | 0 % rH | 2 | = 0 |
| ☁ | humidification set point | 50.0 % rH | 1 | - |
| dFH | analogue output differential | 5.0 % rH | 1 | - |

Tab. 5.j

5.8 (T+H radiant ON/OFF) ON/OFF mode for radiant floor systems

ON/OFF control mode in radiant systems is available for all models of clima (ADCA*, ADCD*, ADCF*), both with temperature control only and temperature plus humidity (modes T or T + H), and is likewise available for the specific model for radiant systems, ADCF000610.

Temperature control uses one relay only:

- R1 for models ADCA000210, ADCA000410 and all models ADCF*;
 - R2 for models ADCA000100, ADCA000110 and all models ADCD*;
- The second relay (R2), if available, is associated with humidity control, as is the analogue output.

Dipswitch configuration:

- dip1: OFF
- dip2: OFF
- dip3: OFF

The remote sensor is used to control the water outlet temperature, and this must be installed, otherwise an error is signalled.

For control two parameters are used that define two thresholds for the water temperature:

- maximum temperature, in heating mode (EHi);
- minimum temperature, in cooling mode (ELo).

To protect the system against critical operating conditions, if such limits are exceeded, an alarm is signalled, EHi (high temperature) or ELo (low temperature) and the actuator is deactivated (relay).

For the control mode, see the modes T and T+H, the specific additional parameters are as follows:

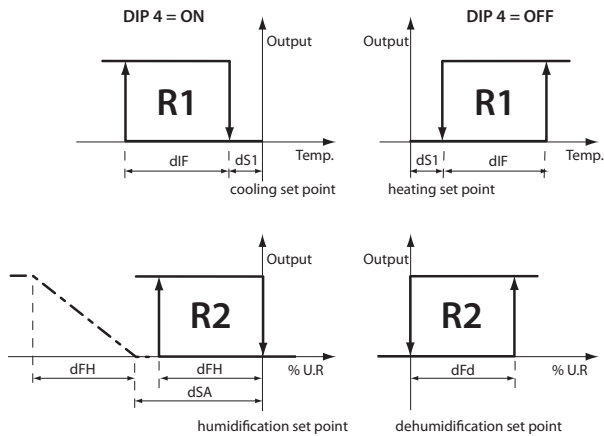

Fig. 5.o

Temperature (top) and humidity control mode (bottom) when LE=2.

Parameters involved:

| Code | Description | Default | LE | Value or link if LE = 1 |
|------|-----------------------------|-----------|----|-------------------------|
| ☃ | day set point in cooling | 24.0 °C | 1 | - |
| ☃ 🌙 | night set point in cooling | 26.0 °C | 1 | - |
| 🔥 | day set point in heating | 20.0 °C | 1 | - |
| 🔥 🌙 | night set point in heating | 18.0 °C | 1 | - |
| dIF | relay differential | 1.0 °C | 1 | - |
| dS1 | relay offset | 0.0 °C | 2 | = 0 |
| dSA | analogue output offset | 0.0 % rH | 2 | = 0 |
| ELo | max. water temp. in heating | 40.0 °C | 1 | - |
| EHi | max. water temp. in cooling | 10.0 °C | 1 | - |
| ☁ | humidification set point | 50.0 % rH | 1 | - |
| 💧 | dehumidification set point | 70.0 % rH | 1 | - |
| dFH | humidification differential | 5.0 % rH | 1 | - |
| dFd | dehumidification diff. | 5.0 % rH | 1 | - |

Tab. 5.k

5.9 (T+H radiant proportional) proportional control mode for radiant floor systems (code ADCF000610)

The control functions use:

- built-in temperature sensor for the room temperature measurement;
- humidity sensor to avoid condensation in cooling mode;
- remote temperature sensor for measuring the heating/cooling water temperature, which must be installed, otherwise an error is signalled;
- ON/OFF output (R1) as the general signal for controlling the zone valve/valves;
- proportional 0 to 10 V output for the control of the mixing valve;
- ON/OFF output (R2) for humidity control.

The dipswitch settings for this specific model of clima allow operation to be selected between ON/OFF and proportional, with different parameter configurations saved by setting the individual DIP configurations, as shown in the table; these can then be recalled by the user based on the selected set of parameters.

The table summarises the configurations that can be selected:

| Dip1 | Dip2 | Dip3 | Model | Set param. |
|------|------|------|--------------------------|------------|
| OFF | OFF | OFF | T+H radiant ON/OFF | #0 |
| ON | OFF | OFF | T+H radiant ON/OFF | #1 |
| OFF | ON | OFF | T+H radiant Proportional | #2 |
| ON | ON | OFF | T+H radiant Proportional | #3 |
| OFF | OFF | ON | T+H radiant Proportional | #4 |
| ON | OFF | ON | T+H radiant Proportional | #5 |
| OFF | ON | ON | T+H radiant Proportional | #6 |
| ON | ON | ON | T+H radiant Proportional | #7 |

Tab. 5.l

DIP4 sets cooling/dehumidification mode (OFF) or heating/humidification (ON), as for the standard models.

Heating control logic

The illustrates operation in heating mode.

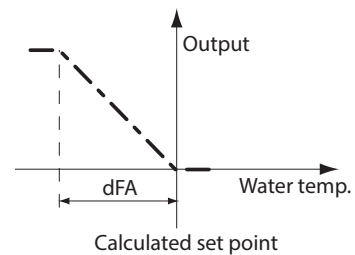

Fig. 5.p

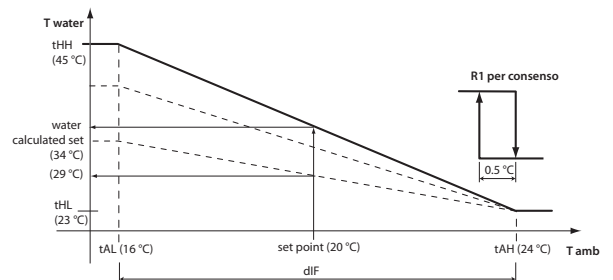

Fig. 5.q

Control calculation:

- Based on the proportional error (Temperature measured – set point) and the integral error, the clima automatically calculates the water outlet set point. The calculation uses the parameters corresponding to the active operating mode (cooling or heating) active: tHH, tHL, tAH, tAL, where $dIF = tAH - tAL$. The integral error is only calculated within the control interval, tAH-tAL according to parameter tIn (integration time). The figure shows an example where the room temperature = room set point and the total error is null, the water outlet set point is 34 °C (for radiant floors).
- The ON/OFF output (R1) sends the signal to activate the system controller and it is activated when the room temperature is less than the maximum limit tAH.
- The water outlet temperature is controlled based on the set point calculated (in point 1) and with a fixed differential dFA. The control functions use the remote sensor, installed on the outlet manifold:
 - If the water temperature is greater than or equal to the set point calculated, the valve is closed.
 - If the water temperature is less than (set point – dFA°) the valve is completely open.
 - In intermediate situations the valve is open proportionally to the deviation from the set point calculated.
 - If you want to increase the stability of the water temperature must enable PID operation through a suitable selection of the integral constant (tIA parameters) and derivative (tdA parameter). By default the integral is selected to 100 s and the derivative is excluded.
- To avoid excessive floor temperatures, the maximum water temperature is compensated, which may be lower than the maximum value set for tHH. This occurs when the system responds, during heating, with excessively fast variations of the room temperature. In the figure this operation is indicated by the dashed line, the line at the bottom, for example, defines a water set point of around 29 °C rather than 34 °C for the same room temperature. The calculation of the maximum value for tHH is based on parameter tr, which defines an observation time in minutes on the value of the integral error:
 - If within the time tr control is active (valve open) and there is an increase in temperature greater than 0.5 °C => tHH is decreased by 1 °C.
 - If the variation was less than 0.5 °C but the integral error is positive (>20% of dIF) => tHH is again decreased by 1 °C.
 - If, on the other hand, the variation is less than 0.5 °C but the integral error is negative (>20% of dIF) => tHH is increased by 1 °C.
 - Recommended value of tr = 30 min., yet this depends on the inertia of the system and the integral error set (tIn).

Note: the value of tHH is not modified as a parameter, rather an offset is added or subtracted.

The purpose of the maximum set point compensation for the water temperature is to make the system work with the lowest possible floor temperature.

In operating conditions outside of the room temperature limits, tAH or tAL, the initial conditions are restored for tHH.

Note: When the temperature is read  on the SMALL field, the H2O symbol is shown to indicate that this is the system water temperature.

Note: Parameter LE=1 or 2 has no influence on the settings of the parameters.

Cooling control logic

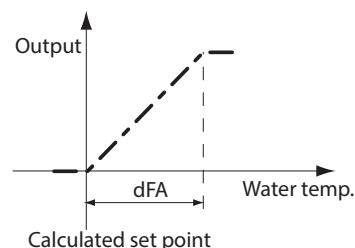

Fig. 5.r

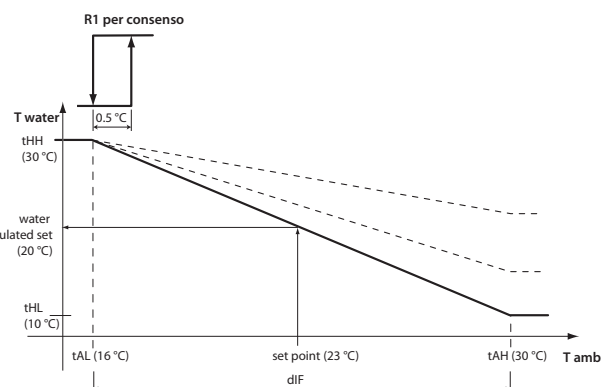

Fig. 5.s

The same rules apply as for heating control, with the following differences:

- The values of the parameters are different for cooling, in particular tHH and tHL;
- The control of the modulating valve is reversed with reference to the water temperature set point: if the temperature is greater than the set point, the valve is open.
- The compensation of the temperature limit is activated using tHL rather than tHH, and the logic is reversed: tHL is increased rather than decreased.
- There is also another limit on the water temperature set point: based on the estimated dewpoint, the set point is limited to values greater than $Temp_dew + ddP$ (dewpoint diff. parameter).

Note: the value of tHL is not modified as a parameter, rather an offset is added or subtracted.

The purpose of the minimum set point compensation for the water temperature is to make the system work with the lowest possible floor temperature, so as to maximise cooling.

In operating conditions outside of the temperature limits greater than tAH or less than tAL, the initial conditions are restored for tHL.

Humidity control for proportional radiant operation:













Code ADCF000610 also uses the humidity sensor, for two functions:

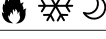







- In cooling mode, it is used for the estimate the dewpoint.
- It can also be used for ambient humidity control, via relay 2, connecting an external humidifier/dehumidifier.





6. TABLE OF PARAMETERS

6.1 Description of the parameters for the standard version

The parameters available depend on the clima model used and the level set (LE = 1 or 2)

| code | parameter | range | default | UOM | note |
|--|---|-----------------|---------|-------------|------|
|  | day temperature set point in cooling | 10 to 50 | 24.0 | °C | |
|  | night temperature set point in cooling | 10 to 50 | 26.0 | °C | |
|  | day temperature set point in heating | 10 to 50 | 20.0 | °C | |
|  | night temperature set point in heating | 10 to 50 | 18.0 | °C | |
|  | single day temperature set point for automatic modes | 10 to 50 | 20.0 | °C | |
|  | single night temperature set point for automatic modes | 10 to 50 | 18.0 | °C | |
| dIF | Temperature differential for relay 1 This is an absolute value and is added to or subtracted from the set point depending on the control mode, cooling or heating. | 0.1 to 10 | 1.0 | °C | |
| dF2 | Temperature differential for relay 2. This is an absolute value and is added to or subtracted from the set point depending on the control mode, cooling or heating. | 0.1 to 10 | 1.0 | °C | |
| dS1 | Temperature offset for relay 1 This value is added to or subtracted from the set point based on the active control mode. May be positive or negative, so as to offer complete flexibility in the position of the step. | -10 to 10 | 0.5 | °C | |
| dFA | Analogue output differential This value is added to or subtracted from the set point according to the control mode selected, cooling or heating. | 0 to 10 | 1.0 | °C | |
| dSA | Analogue output offset from to the set point This value is added to or subtracted from to the set point according to the operating mode, cooling or heating. | -10 to 10 | 0.0 | °C/ % rH | |
| EHI | Maximum water temperature for ON/OFF radiant floor heating control (mode 8, all dipswitches off). The screen shows alarm EHI and the relay output is deactivated, irrespective of the control mode. | 10 to 80 | 40 | °C | |
| ELo | Minimum water temperature for ON/OFF radiant floor cooling control (mode 8, all dipswitches off). The screen shows alarm ELo and the relay output is deactivated, irrespective of the control mode. | 0 to 50 | 10 | °C | |
|  | Humidification set point | 10 to 70 | 50.0 | % rH | |
|  | Dehumidification set point | 10 to 70 | 70.0 | % rH | |
| dFH  | Humidity differential for the activation of the analogue output and the relay. | 1 to 20 | 5.0 | % rH | |
| dFd  | Dehumidification differential for the activation of the relay. | 1 to 20 | 5.0 | % rH | |
| SFH   | Parameter to define the humidification/dehumidification status in day and night mode Activates or deactivates humidification or dehumidification control (based on DIP 4) with the time bands. The parameter can have the following three values 0 - Time bands disabled. The humidification/dehumidification control is always active, if featured, and is configured in relation to dip4 1 - Time bands enabled: When switching to the daytime band, humidification/dehumidification control (depends on dip4) is activated. When switching to the night band, humidification/dehumidification control (depends on dip4) is deactivated. 2 - Time bands enabled: When switching to the daytime band, humidification/dehumidification control (depends on dip4) is deactivated. When switching to the night band, humidification/dehumidification control (depends on dip4) is activated. | 0 to 2 | 0 | - | |
| AUt  | Humidity set point automatically compensated by the outside temperature If humidity control is featured, the ambient humidity is controlled with an automatic set point, defined from 1H to 7H using the buttons, as specified in the corresponding table (see page 15). If set to OFF the mode is disabled. Setting one of the levels in the table, the controller independently sets a humidity set point in relation to the outside temperature. | OFF 1H to 7H | OFF | - | |

| code | parameter | range | default | UOM | note |
|---|---|----------------|---------|-----|------|
| | Parameter for set point compensation | | | | |
| CSt | Parameter CSt enables and sets the gain for set point compensation according to the outside temperature. If CSt = 0 compensation is disabled. Also see parameters Ctt and CtS. | -1 to 1 | 0.0 | °C | |
| CdF | Max differential for the compensated set point The maximum value for the compensated set point is limited by this parameter. In heating mode, if the difference calculated for set point compensation is higher than CdF, the instrument uses CdF as the maximum difference from the set point. Similarly, in cooling mode if the difference calculated for set point compensation is less than CdF, the instrument uses CdF as the maximum difference from the set point.. | 0 to 20 | 2.0 | °C | |
| Ctt | Threshold for set point compensation in heating mode Temperature set point compensation in heating based on the outside temperature measurement: compensated set point = setpoint – (set point – Text – Ctt) * CSt Compensation is activated only if: Text < set point – Ctt | 0 to 25 | 10.0 | °C | |
| CtS | Threshold for set point compensation in cooling mode. Temperature set point compensation in cooling based on the outside temperature measurement: compensated set point = setpoint + (Text – set point – CtS) * CSt Compensation is activated only if: Text > set point + CtS | 0 to 25 | 10.0 | °C | |
| AdC | Configuration T2A e T2A+H Additional modes for the automatic operation: For temperature control only (T2A): Configuration 1: temperature control with set point and dead band only (2xdS1). Configuration 2: temperature control only with automatic changeover of the set point. Configuration 3: temperature control only with cooling and heating set point, automatic changeover and manual ON/OFF control for outlet fan. | 1 to 3 | 1 | - | |
| | For temperature + humidity control (T2A+H): Configuration 1: temperature control with set point and dead band only (2xdS1). Two set points for humidity. Configuration 2: temperature and humidity control with cooling and heating set point and automatic changeover. | 1 to 2 | | - | |
| dyS | Active display configuration Used to set the values shown in the large and small fields on the display | 1 to 4 | 1 | - | |
| rtC  | Current time The large field displays the hours and the small field the minutes | 00:00 23:59 | 00.00 | h | |
| SLP  | Duration of manual day-night mode changeover The large field displays the hours and the small field the minutes (15 minute steps) | 0 to 12 | 8 h | h | |
| dAy  | Day band threshold The large field displays the hours and the small field the minutes (15 minute steps) | 00:00 23:59 | 8.00 | h | |
| nlt  | Night band threshold The large field displays the hours and the small field the minutes (15 minute steps) | 00:00 23:59 | 20.00 | h | |
| dl | Digital input configuration OFF: disabled 1 select remote cooling /heating 2 remote ON/OFF 3 select day/night(set alternativo) 4 remote alarm | OFF to 4 | OFF | - | |
| POL | Digital contact polarity Used to choose whether to consider the digital input active when closed or open or alternatively whether or not there is voltage in the optically-isolated version. Voltage-free contact: nE: active when the input is closed PO: active when the input is open Optically isolated: nE: active when voltage is present at the input PO: active when voltage is not present at the input | nE, PO | nE | - | |
| EI   | Control cooling/heating operating mode Enables the possibility to define the operating mode, cooling/heating, by parameter rather than by DIP 4. dIS: Parameter EI is disabled, cooling/heating mode is selected by DIP 4 on the rear. En: Parameter EI is enabled, cooling/heating mode is selected by parameter EI. | dIS, En | dIS | - | |
| EI   | Select cooling/heating operation only active if this mode is enabled by the previous parameter. Selects the mode, cooling or heating. E: The instrument works in cooling mode I: The instrument works in heating mode | E, I | E | - | |









| code | parameter | range | default | UOM | note |
|--|--|-----------|---------|------|------|
| LIn | Instrument output control mode Enabling this parameter allows the outputs to be controlled directly via the serial connection. Warning, if enabled no control is performed independently by the instrument. If active and the supervisor does not query the instrument for more than two minutes, the outputs are automatically disabled and the no link error (ELn) is signalled on the display. no: the function is disabled. yES: the function is enabled. | no, yES | no | - | |
|  CAL+ Int | Inside temperature calibration, digital sensor or NTC Within a maximum of ± 10 °C | -10 to 10 | 0.0 | °C | |
|  CAL+ ESt | Outside temperature calibration, NTC sensor Within a maximum of ± 10 °C | -10 to 10 | 0.0 | °C | |
|  CAL+ HUn | Digital humidity sensor calibration. Within a maximum of $\pm 15\%$ rH | -15 to 15 | 0.0 | % rH | |
| LE | Parameter access level Level of access the control parameters for the active mode: Level 1: basic access, only the essential parameters for correct operation. Level 2: advanced access, used to set all the parameters for the selected control mode. | 1, 2 | 1 | - | |
|  LOC | Lock The lock parameter used to disable some functions of the instrument, as per the following settings: LOC = OFF LOC = 1: The UP/DOWN and time bands buttons are disabled LOC = 2: Only the time bands button is disabled In these cases, the LOCK symbol is shown on the display whenever attempting to perform an unauthorised operation.. | OFF to 2 | OFF | | |
|  Unt | Temperature display mode Sets the temperature display mode, in degrees Fahrenheit or Centigrade. Unlike direct selection using the button, if changing the temperature display mode using parameter Unt, this becomes the default display mode when switching the instrument on. | °C, °F | °C | - | |
| nEd | Parameter for control with average value sensor values Defines the average control temperature (Tm), based on the weighted average of the inside temperature (TI) and outside temperature (TE). Both the measurements must be valid and Tm is achieved with the following formula: $Tm = (TI * (100 - nEd) + TE * nEd) / 100$ The average temperature calculated is used for control and display. | 0 to 100 | 0.0 | % | |
| Add | RS485 serial address (the external option code IROPZ48500 is required). It can be read by the supervisor and can only be changed with direct access on the instrument. | 1 to 207 | 1 | - | |
| SEr | Select serial communication protocol 0: CAREL protocol 9.6 kb/s 1: CAREL protocol 19.2 kb/s 2: Modbus 9.6 kb/s, even parity, 8 bits, 1 stop 3: Modbus 19.2 kb/s, even parity, 8 bits, 1 stop 4: Modbus 9.6 kb/s, no parity, 8 bits, 2 stop 5: Modbus 19.2 kb/s, no parity, 8 bits, 2 stop | 0 to 5 | 1 | - | |
| PS | Password for accessing the parameters Set to 0: no password is required. Set other than zero: the same value must be entered to access the parameters. | 0 to 999 | 0 | - | |
| FAC+ SET | Factory set Reset the default values (manufacturer) on the instrument for the current mode. | no, yES | no | - | |

Tab. 6.a



Note: the "+" symbol means that the parameter is shown on 2 fields.

6.2 Additional parameters, available in version T+H for proportional control of radiant systems (cod. ADCF000610)

| code | parameter | range | default | UOM | notes |
|---|--|------------|---------|------|-------|
| tHH  | High water temperature limit in heating | 15 to 80 | 45.0 | °C | |
| tHL  | Low water temperature limit in heating | 15 to 80 | 23.0 | °C | |
| tHH  | High water temperature limit in cooling | 5 to 35 | 30.0 | °C | |
| tHL  | Low water temperature limit in cooling | 5 to 35 | 10.0 | °C | |
| tAH  | High room temperature limit in heating | 15 to 40 | 24.0 | °C | |
| tAL  | Low room temperature limit in heating | 15 to 40 | 16.0 | °C | |
| tAH  | High room temperature limit in cooling | 5 to 35 | 30.0 | °C | |
| tAL  | Low room temperature limit in cooling | 5 to 35 | 16.0 | °C | |
| tIn | Integration time in minutes to calculate integral error in the water temperature control algorithm | 1 to 100 | 10 | min. | |
| tr | Observation time for compensation of the water temperature limit (OFF = compensation not enabled) | OFF to 255 | OFF | min. | |
| ddP | Dewpoint delta for adjusting the water temp. set point | -20...20 | 0,0 | °C | |
| EdP | Enable water temp. set point limit to avoid condensation | no, yES | no | - | |
| tIA | Integration time for water mixing valve | OFF...999 | 100 | s | |
| tdA | Derivate time for water mixing valve | OFF...999 | 0 | s | |
| dFA | Regulation band for for water mixing valve | 0.1...20.0 | 4 | °C | |

Tab. 6.b

7. ALARMS AND SIGNALS

Below is the table of alarms.



Note: When the value is not shown in the SMALL or LARGE field, three dashes "----" are displayed.

7.1 Table of alarms

| code on display | description | reset | effect |
|-----------------|---|-----------|---|
| EE | system/memory error | manual | stops all outputs |
| Eth | temperature+humidity sensor fault | automatic | stops all outputs and disables the calculation of the dewpoint |
| E1 | built-in NTC temperature sensor fault | automatic | stops all outputs |
| E2 | remote temperature sensor fault | automatic | stops compensation if active, and control on average if enabled |
| Ert | RTC alarm | automatic | - |
| EHi | high control temperature alarm, radiant floor | automatic | stops all outputs |
| ELo | low control temperature alarm, radiant floor | automatic | stops all outputs |
| ELn | serial connection alarm | automatic | only active if I/Os managed via serial connection |
| ALE | external alarm from digital input | automatic | signal-only alarm from external contact (humidifier) |

Tab. 7.a

8. TECHNICAL SPECIFICATIONS

8.1 Technical specifications

| | |
|---|--|
| Power supply | 24 Vac +10 to -15%, 50/60Hz, 1 VA 24 to 32 Vdc, 1W Class 2 safety power supply Min. cable cross-section 0.5 mm ² . Power supply compatible with compactSteam (G – G0) |
| Operating temperature | 0T60 °C, 10 to 90% rH not-condensing |
| Storage temperature | -20T70 °C, 10 to 90% rH not-condensing |
| Environmental pollution | normal |
| Pollution | degree 2 |
| Software class and structure | A |
| Type of action | 1C |
| Index of protection | IP20 |
| Ball pressure test temperature on plastic of front casing | 125 °C |
| Classification according to protection against electric shock | 2, to be integrated into class 1 or 2 appliances |
| Period of stress across the insulating parts | long |
| Immunity against voltage surges | category 2 |
| Wire cross-section | from 0.5 to 1.5 mm ² |
| Precision of inside temperature measurement | ± 1 °C from 0 to 60 °C |
| Precision of outside temperature measurement | NTC (standard CAREL 10 kΩ) range -40T80 °C precision ± 0.5 °C + sensor precision: ± 1 °C from 0 to 40 °C ± 1.5 °C from -40 to 0 °C and from 40 and 80 °C |
| 0 to 10 V analogue output, not isolated, for proportional control | precision ±5% max load 5 kΩ, max current 2 mA |
| Relay approval | EN60730-1: NO 1(1)A 250 Vac cos = 0.4, 100,000 cycles UL-873: NO 1A resistive 24 Vac, 30 Vdc, 100,000 cycles PILOT DUTY: 24 Vac, make 15 A, break 1 A, 30,000 cycles |
| Precision of humidity measurement (in models where featured) range 10 to 90% | ± 3% rH at 25 °C ± 5% rH 0 to 60 °C |
| Dimensions | 135x86x36mm |

Tab. 8.a

8.2 Wiring

| | |
|--|---|
| Digital input | Non-isolated version: direct connection of the voltage-free contact; contact closing current: 3 to 5 mA. Isolated version: with external power supply to 24 Vac contact: class 2 safety external power supply separate from the 24 Vac power supply to the instrument |
| Outside temperature sensor connection with standard CAREL sensor (10 K 25 °C B=3435): | Maximum length: 30 m, min. cable cross-section 0.5 mm ² . |
| Digital input connection | Maximum length 10 m, min. cable cross-section 0.5 mm ² . |
| Analogue output connection | Maximum length 10 m, min. cable cross-section 0.5 mm ² . |
| Relay output connections: | Maximum length 30 m, cable cross-section from 1.5 to 2.5 mm ² , class 2 reinforced insulation from the instrument. Basic insulation between the relays. |
| UL specifications for connections: | Use copper wires approved for a temperature of 75 °C. Minimum cross-section AWG 22-14 rigid or flexible. To tighten the terminals, apply a torque of 7 Lb/In for the black terminals (SAURO) To use the instrument in compliance with UL-873, a load with a maximum voltage 24 Vac, class 2, can be connected to the relay output. |

Tab. 8.b



Warning: All the connections, except for the relays, must be connected to very low voltage circuits with reinforced insulation.

9. APPENDIX

9.1 Supervisor parameters for CAREL and Modbus® protocol

Unit code 57 (all codes except for ADCF000610)

Digital variables

| par | "CAREL sup index" | "Modbus index" | description | min | max | def | UOM | R/W | note |
|-----|-------------------|----------------|--|-----|-----|-----|-----|-----|-------------------------|
| - | 1 | 1 | "Unit on or off 0= off - 1= on" | 0 | 1 | 0 | | R/W | |
| LIn | 2 | 2 | "Control actuators (relays, analogue output) from serial 0= function disabled - 1= function enabled" | 0 | 1 | 0 | | R/W | |
| Unt | 3 | 3 | "Parameter for setting temperature display mode Farh = 1 - Celsius =0" | 0 | 1 | | | R/W | |
| - | 4 | 4 | "RTC status not enabled 0= RTC operation ok - 1= RTC off" | 0 | 1 | | | R/W | |
| - | 5 | 5 | "RTC fitted 0= fitted - 1= not fitted" | 0 | 1 | - | | R | |
| - | 6 | 6 | "Parameter for setting day/night operating mode 0= Day - 1= night" | 0 | 1 | | | R/W | |
| LE | 7 | 7 | "Parameter for setting access level to parameters from user interface 0= level 1 - 1= level 2" | 0 | 1 | | | R/W | |
| POL | 8 | 8 | "Parameter for setting digital contact polarity 0= nE - 1= PO" | 0 | 1 | | | R/W | |
| EI | 9 | 9 | "Enable Cooling/Heating by parameter (not dipswitch) 0= function disabled (dIS) - 1= function enabled (En)" | 0 | 1 | | | R/W | |
| EI | 10 | 10 | "Cooling/heating setting, if EI=En 0= Cooling (E) - 1= Heating (I)" | 0 | 1 | | | R/W | if EI=En |
| - | 11 | 11 | "Digital humidity sensor fitted 0= fitted - 1= NOT FITTED" | 0 | 1 | - | | R | |
| - | 17 | 16 | "Operating mode for control: 0= Cooling - 1= Heating" | 0 | 1 | - | | R | |
| - | 18 | 17 | "Changeover status: 0= not active - 1= active" | 0 | 1 | - | | R/W | W if LIn=1 |
| - | 19 | 18 | "Cooling control status of relay 1: 0= not active - 1= active" | 0 | 1 | - | | R/W | W if LIn=1 |
| - | 20 | 19 | "Cooling control status of relay 2: 0= not active - 1= active" | 0 | 1 | - | | R/W | W if LIn=1 |
| - | 21 | 20 | "Heating control status of relay 1: 0= not active - 1= active" | 0 | 1 | - | | R/W | W if LIn=1 |
| - | 22 | 21 | "Heating control status of relay 2: 0= not active - 1= active" | 0 | 1 | - | | R/W | W if LIn=1 |
| - | 23 | 22 | "Humidification control status: 0= not active - 1= active" | 0 | 1 | - | | R/W | W if LIn=1 |
| - | 24 | 23 | "Dehumidification control status: 0= not active - 1= active" | 0 | 1 | - | | R/W | W if LIn=1 |
| - | 25 | 24 | "Automatic control status in cooling mode: 0= not active - 1= active" | 0 | 1 | - | | R/W | W if LIn=1 |
| - | 26 | 25 | "Automatic control status in heating mode: 0= not active - 1= active" | 0 | 1 | - | | R/W | W if LIn=1 |
| - | 27 | 26 | "Status of relay 1: 0= open - 1= closed" | 0 | 1 | - | | R | |
| - | 28 | 27 | "Status of relay 2: 0= open - 1= closed" | 0 | 1 | - | | R | |
| - | 29 | 28 | "Status of external alarm (if ALE is displayed) 0= not active - 1= active" | 0 | 1 | - | | R | |
| - | 30 | 29 | "Status of remote NTC sensor alarm 0= not active - 1= active" | 0 | 1 | - | | R | |
| - | 31 | 30 | "Status of remote digital sensor T+H 0= not active - 1= active" | 0 | 1 | - | | R | |
| - | 32 | 31 | "Control status with antifreeze 0= not active - 1= active" | 0 | 1 | - | | R | |
| - | 33 | 32 | "Status of RTC alarm 0= not active - 1= active" | 0 | 1 | - | | R | |
| - | 34 | 33 | "Status of inside NTC sensor alarm 0= not active - 1= active" | 0 | 1 | - | | R | |
| - | 35 | 34 | "Status of temperature display mode Farh = 1 - Celsius =0" | 0 | 1 | | | R/W | temporary status in RAM |
| - | 36 | 35 | "Status of day/night operating mode 0= Day - 1= night" | 0 | 1 | | | R/W | temporary status in RAM |

| par | "CAREL sup index" | "Modbus index" | description | min | max | def | UOM | R/W | note |
|-----|-------------------|----------------|---|-----|-----|-----|-----|-----|------|
| - | 37 | 36 | "Status of EEPROM alarm 0= not active - 1= active" | 0 | 1 | - | | R | |
| - | 38 | 37 | "Serial connection alarm if parameter Lln enabled 0= not active - 1= active" | 0 | 1 | - | | R | |
| - | 39 | 38 | "High water temperature alarm for model T+H rad. 0= not active - 1= active" | 0 | 1 | - | | R | |
| - | 40 | 39 | "Low water temperature alarm for model T+H rad. 0= not active - 1= active" | 0 | 1 | - | | R | |
| - | 49 | 48 | "Reading of dipswitch 4 0= off - 1= on" | 0 | 1 | - | | R | |
| - | 50 | 49 | "Reading of dipswitch 1 0= off - 1= on" | 0 | 1 | - | | R | |
| - | 51 | 50 | "Reading of dipswitch 2 0= off - 1= on" | 0 | 1 | - | | R | |
| - | 52 | 51 | "Reading of dipswitch 3 0= off - 1= on" | 0 | 1 | - | | R | |
| - | 53 | 52 | "Digital input reading 1= open - 0= closed" | 0 | 1 | - | | R | |

Tab. 9.a







Integer variables

| par. | CAREL sup. index | Modbus® index | description | min | max | def. | UOM | R/W | note |
|------|------------------|---------------|---|-----|------|------|-----|-----|------|
| - | 1 | 150 | internal RTC reading in minutes (e.g.: 13:13 equals 793 min.) | 0 | 1439 | - | min | R/W | |
| - | 3 | 152 | status of the mode changeover timer (day if in night mode, night if in day mode) | 0 | 720 | - | min | R/W | |
| AUt | 7 | 130 | parameter AUt | 0 | 7 | 0 | | R/W | |
| dI | 8 | 131 | parameter dI | 0 | 4 | 0 | | R/W | |
| dyS | 9 | 132 | parameter dyS | 1 | 4 | 1 | | R/W | |
| AdC | 10 | 133 | parameter AdC for automatic model selection | 1 | 3 | 1 | | R/W | |
| SLP | 11 | 134 | duration of the mode changeover timer (day if in night mode, night if in day mode) | 0 | 12 | 8 | h | R/W | |
| - | 12 | 135 | day band threshold | 0 | 1439 | 480 | min | R/W | |
| - | 13 | 136 | night band threshold | 0 | 1439 | 1200 | min | R/W | |
| Add | 14 | 137 | 485 serial address | 1 | 207 | 1 | | R | |
| LOC | 15 | 138 | parameter LOC | 0 | 2 | 0 | | R/W | |
| nEd | 16 | 139 | parameter nEd | 0 | 100 | 0 | % | R/W | |
| - | 17 | 140 | model of unit used | 0 | 7 | - | | R | |
| SFH | 18 | 141 | parameter SFH | 0 | 2 | 0 | | R/W | |
| PS | 19 | 142 | parameter PS (if = 0 no password) | 0 | 999 | 0 | | R/W | |
| SER | 20 | 143 | parameter SER | 0 | 5 | 1 | | R/W | |

Tab. 9.b

Analogue variables

| par. | CAREL sup. index | Modbus® index | description | min | max | def. | UOM | R/W | note |
|------|------------------|---------------|---|-----|-----|------|-------|-----|------------------------------------|
| - | 1 | 29 | built-in NTC temperature sensor | -40 | 70 | - | °C | R | the calibration value is not added |
| - | 2 | 30 | remote NTC temperature sensor | -40 | 80 | - | °C | R | the calibration value is not added |
| - | 3 | 31 | minimum inside temperature recorded from unit ON | -40 | 70 | - | °C | R | the calibration value is not added |
| - | 4 | 32 | maximum inside temperature recorded from unit ON | -40 | 70 | - | °C | R | the calibration value is not added |
| - | 5 | 33 | minimum outside temperature recorded from unit ON | -40 | 80 | - | °C | R | the calibration value is not added |
| - | 6 | 34 | maximum outside temperature recorded from unit ON | -40 | 80 | - | °C | R | the calibration value is not added |
| - | 7 | 35 | digital temperature sensor | -40 | 70 | - | °C | R | the calibration value is not added |
| - | 8 | 36 | digital humidity sensor value | 0 | 99 | - | %U.R. | R | |
| - | 13 | 41 | analogue output value | 0 | 100 | - | | R | |
| - | 14 | 42 | PWM value for cooling | 0 | 100 | - | | R/W | W if Lln=1 |

| par. | CAREL sup. index | Modbus® index | description | min | max | def. | UOM | R/W | note |
|--|------------------|---------------|---|-----|-----|----------------------|-------|-----|------------|
| - | 15 | 43 | PWM value for heating | 0 | 100 | - | | R/W | W if LIn=1 |
| - | 16 | 44 | PWM value for humidification | 0 | 100 | - | | R/W | W if LIn=1 |
|  | 22 | 1 | day temperature set point in cooling | 10 | 40 | 24 | °C | R/W | |
|  | 23 | 2 | night temperature set point in cooling | 10 | 40 | 26 | °C | R/W | |
|  | 24 | 3 | day temperature set point in heating | 10 | 40 | 20 | °C | R/W | |
|  | 25 | 4 | night temperature set point in heating | 10 | 40 | 18 | °C | R/W | |
| dIF | 26 | 5 | temperature differential dIF | 0 | 10 | 1 | °C | R/W | |
| dF2 | 27 | 6 | temperature differential dF2 | 0 | 10 | 1 | °C | R/W | |
| dS1 | 28 | 7 | temperature differential dS1 | -10 | 10 | 0.5T2A+H 0 others | °C | R/W | |
| dFA | 29 | 8 | temperature differential dFA | -10 | 10 | 1 | °C | R/W | |
| dSA | 30 | 9 | temperature differential dSA | -10 | 10 | 0.5T2A+H 0 others | °C | R/W | |
|  | 31 | 10 | humidification set point | 10 | 70 | 50 | %U.R. | R/W | |
|  | 32 | 11 | dehumidification set point | 10 | 70 | 70 | %U.R. | R/W | |
| dFH | 33 | 12 | humidification differential dFH | 1 | 20 | 5 | %U.R. | R/W | |
| dFd | 34 | 13 | dehumidification differential dFd | 1 | 20 | 5 | %U.R. | R/W | |
| CAL+Int | 35 | 14 | inside temperature calibration | -10 | 10 | 0 | °C | R/W | |
| CAL+Est | 36 | 15 | outside temperature calibration | -10 | 10 | 0 | °C | R/W | |
| CAL+HUn | 37 | 16 | humidity sensor calibration | -15 | 15 | 0 | %U.R. | R/W | |
| CtS | 38 | 17 | threshold for set point compensation in cooling | 0 | 25 | 10 | °C | R/W | |
| Ctt | 39 | 18 | threshold for set point compensation in heating | 0 | 25 | 10 | °C | R/W | |
| CdF | 40 | 19 | max differential for set point compensation | 0 | 20 | 2 | °C | R/W | |
| CSt | 41 | 20 | parameter for set point compensation | -1 | 1 | 0 | | R/W | |
| EHi | 42 | 21 | maximum water temperature for model T+H radiant | 10 | 80 | 40 | °C | R/W | |
| ELo | 43 | 22 | minimum water temperature for model T+H radiant | 0 | 50 | 10 | °C | R/W | |

Tab. 9.c

 **Note:** In the supervisor parameters, the set point for the automatic modes (day and night) is saved to both values (cooling/heating); when setting, simply change the heating set point only, and the setting will be automatically copied to the corresponding cooling set point.

 **Note:** All the analogue variables (set point, differential, sensor calibration ...) are expressed in tenths if read with the CAREL protocol, and expressed in hundredths if read with the Modbus® protocol (example: 24.3 °C: CAREL supervisor = 243, Modbus® supervisor = 2430)

Unit code 58 (code ADCF000610 only)

Digital variables

| par | "CAREL sup index" | "Modbus index" | description | min | max | def | UOM | R/W | note |
|-----|-------------------|----------------|--|-----|-----|-----|-----|-----|-------------------------|
| - | 1 | 1 | "Unit on or off 0= off - 1= on" | 0 | 1 | 0 | | R/W | |
| LIn | 2 | 2 | "Control actuators (relays, analogue output) from serial 0= function disabled - 1= function enabled" | 0 | 1 | 0 | | R/W | |
| Unt | 3 | 3 | "Parameter for setting temperature display mode Farh = 1 - Celsius =0" | 0 | 1 | | | R/W | |
| - | 4 | 4 | "RTC status not enabled 0= RTC operation ok - 1= RTC off" | 0 | 1 | | | R/W | |
| - | 5 | 5 | "RTC fitted 0= fitted - 1= not fitted" | 0 | 1 | - | | R | |
| - | 6 | 6 | "Parameter for setting day/night operating mode 0= Day - 1= night" | 0 | 1 | | | R/W | |
| LE | 7 | 7 | "Parameter for setting access level to parameters from user interface 0= level 1 - 1= level 2" | 0 | 1 | | | R/W | |
| POL | 8 | 8 | "Parameter for setting digital contact polarity 0= nE - 1= PO" | 0 | 1 | | | R/W | |
| EI | 9 | 9 | "Enable Cooling/Heating by parameter (not dipswitch) 0= function disabled (dIS) - 1= function enabled (En)" | 0 | 1 | | | R/W | |
| EI | 10 | 10 | "Cooling/heating setting, if EI=En 0= Cooling (E) - 1= Heating (I)" | 0 | 1 | | | R/W | if EI=En |
| - | 11 | 11 | "Digital humidity sensor fitted 0= fitted - 1= NOT FITTED" | 0 | 1 | - | | R | |
| EdP | 12 | 12 | "Enable dewpoint calculation 0= no - 1= yES" | 0 | 1 | - | | R/W | |
| - | 17 | 16 | "Operating mode for control: 0= Cooling - 1= Heating" | 0 | 1 | - | | R | |
| - | 18 | 17 | "Changeover status: 0= not active - 1= active" | 0 | 1 | - | | R/W | W if LIn=1 |
| - | 19 | 18 | "Cooling control status of relay 1: 0= not active - 1= active" | 0 | 1 | - | | R/W | W if LIn=1 |
| - | 20 | 19 | "Cooling control status of relay 2: 0= not active - 1= active" | 0 | 1 | - | | R/W | W if LIn=1 |
| - | 21 | 20 | "Heating control status of relay 1: 0= not active - 1= active" | 0 | 1 | - | | R/W | W if LIn=1 |
| - | 22 | 21 | "Heating control status of relay 2: 0= not active - 1= active" | 0 | 1 | - | | R/W | W if LIn=1 |
| - | 23 | 22 | "Humidification control status: 0= not active - 1= active" | 0 | 1 | - | | R/W | W if LIn=1 |
| - | 24 | 23 | "Dehumidification control status: 0= not active - 1= active" | 0 | 1 | - | | R/W | W if LIn=1 |
| - | 25 | 24 | "Automatic control status in cooling mode: 0= not active - 1= active" | 0 | 1 | - | | R/W | W if LIn=1 |
| - | 26 | 25 | "Automatic control status in heating mode: 0= not active - 1= active" | 0 | 1 | - | | R/W | W if LIn=1 |
| - | 27 | 26 | "Status of relay 1: 0= open - 1= closed" | 0 | 1 | - | | R | |
| - | 28 | 27 | "Status of relay 2: 0= open - 1= closed" | 0 | 1 | - | | R | |
| - | 29 | 28 | "Status of external alarm (if ALE is displayed) 0= not active - 1= active" | 0 | 1 | - | | R | |
| - | 30 | 29 | "Status of external NTC sensor alarm (water system) 0= not active - 1= active" | 0 | 1 | - | | R | |
| - | 31 | 30 | "Status of digital sensor T+H 0= not active - 1= active" | 0 | 1 | - | | R | |
| - | 32 | 31 | "Control status with antifreeze 0= not active - 1= active" | 0 | 1 | - | | R | |
| - | 33 | 32 | "Status of RTC alarm 0= not active - 1= active" | 0 | 1 | - | | R | |
| - | 34 | 33 | "Status of inside NTC sensor alarm 0= not active - 1= active" | 0 | 1 | - | | R | |
| - | 35 | 34 | "Status of temperature display mode Farh = 1 - Celsius =0" | 0 | 1 | | | R/W | temporary status in RAM |
| - | 36 | 35 | "Status of day/night operating mode 0= Day - 1= night" | 0 | 1 | | | R/W | temporary status in RAM |
| - | 37 | 36 | "Status of EEPROM alarm 0= not active - 1= active" | 0 | 1 | - | | R | |
| - | 38 | 37 | "Serial connection alarm if parameter LIn enabled 0= not active - 1= active" | 0 | 1 | - | | R | |
| - | 39 | 38 | "High water temperature alarm for model T+H rad. 0= not active - 1= active" | 0 | 1 | - | | R | |

| par | "CAREL sup index" | "Modbus index" | description | min | max | def | UOM | R/W | note |
|-----|-------------------|----------------|---|-----|-----|-----|-----|-----|------|
| - | 40 | 39 | "Low water temperature alarm for model T+H rad. 0= not active - 1= active" | 0 | 1 | - | | R | |
| - | 49 | 48 | "Reading of dipswitch 4 0= off - 1= on" | 0 | 1 | - | | R | |
| - | 50 | 49 | "Reading of dipswitch 1 0= off - 1= on" | 0 | 1 | - | | R | |
| - | 51 | 50 | "Reading of dipswitch 2 0= off - 1= on" | 0 | 1 | - | | R | |
| - | 52 | 51 | "Reading of dipswitch 3 0= off - 1= on" | 0 | 1 | - | | R | |
| - | 53 | 52 | "Digital input reading 1= open - 0= closed" | 0 | 1 | - | | R | |

Tab. 9.d













Integer variables

| par. | CAREL sup. index | Modbus® index | description | min | max | def. | UOM | R/W | note |
|------|------------------|---------------|---|-----|------|------|------|-----|------|
| - | 1 | 150 | internal RTC reading in minutes (e.g.: 13:13 equals 793 min.) | 0 | 1439 | - | min | R/W | |
| - | 3 | 152 | status of the mode changeover timer (day if in night mode, night if in day mode) | 0 | 720 | - | min | R/W | |
| AUt | 6 | 130 | parameter AUt | 0 | 7 | 0 | | R/W | |
| dl | 7 | 131 | parameter dl | 0 | 4 | 0 | | R/W | |
| dyS | 8 | 132 | parameter dyS | 1 | 4 | 1 | | R/W | |
| SLP | 9 | 133 | duration of the mode changeover timer (day if in night mode, night if in day mode) | 0 | 12 | 8 | h | R/W | |
| - | 10 | 134 | day band threshold | 0 | 1439 | 480 | min | R/W | |
| - | 11 | 135 | night band threshold | 0 | 1439 | 1200 | min | R/W | |
| Add | 12 | 136 | 485 serial address | 1 | 207 | 1 | | R | |
| LOC | 13 | 137 | parameter LOC | 0 | 2 | 0 | | R/W | |
| nEd | 14 | 138 | parameter nEd | 0 | 100 | 0 | % | R/W | |
| - | 15 | 139 | configuration set by dip1, 2 & 3 | 0 | 7 | 0 | | R/W | |
| SFH | 16 | 140 | humidification/dehumidification & day/night status parameter | 0 | 2 | 0 | - | R/W | |
| PS | 17 | 141 | parameter PS | 0 | 999 | 0 | | R/W | |
| tIn | 18 | 142 | parameter tIn | 1 | 100 | 10 | min. | R/W | |
| tr | 19 | 143 | parameter tr (OFF = 0) | 0 | 255 | 0 | min. | R/W | |
| SEr | 20 | 144 | parameter SEr | 0 | 5 | 1 | | R/W | |
| tIA | 21 | 145 | parameter tIA | 0 | 999 | 100 | s | R/W | |
| tdA | 22 | 146 | parameter tdA | 0 | 999 | 0 | s | R/W | |

Tab. 9.e

Analogue variables

| par. | CAREL sup. index | Modbus® index | description | min | max | def. | UOM | R/W | note |
|--|------------------|---------------|---|-----|-----|------|-----|-----|------------------------------------|
| - | 1 | 35 | inside NTC temperature sensor | -40 | 70 | - | C | R | the calibration value is not added |
| - | 2 | 36 | remote NTC temperature sensor (water system) | -40 | 80 | - | C | R | the calibration value is not added |
| - | 3 | 37 | minimum inside temperature recorded from unit ON | -40 | 70 | - | C | R | the calibration value is not added |
| - | 4 | 38 | maximum inside temperature recorded from unit ON | -40 | 70 | - | C | R | the calibration value is not added |
| - | 5 | 39 | minimum water temperature recorded from unit ON | -40 | 80 | - | C | R | the calibration value is not added |
| - | 6 | 40 | maximum water temperature recorded from unit ON | -40 | 80 | - | C | R | the calibration value is not added |
| - | 7 | 41 | digital temperature sensor | -40 | 70 | - | C | R | the calibration value is not added |
| - | 8 | 42 | digital humidity sensor value | 0 | 99 | - | %rH | R | |
| - | 13 | 47 | analogue output value | 0 | 100 | - | | R | |
| - | 14 | 48 | PWM value for cooling | 0 | 100 | - | | R/W | W if LIn=1 |
| - | 15 | 49 | PWM value for heating | 0 | 100 | - | | R/W | W if LIn=1 |
| - | 16 | 50 | PWM value for humidification | 0 | 100 | - | | R/W | W if LIn=1 |
| - | 21 | 55 | set point calculated for radiant system water | 5 | 80 | - | C | R | |
| - | 22 | 56 | dewpoint calculated | - | - | - | C | R | |
| - | 23 | 57 | maximum temperature limit for water set, tHH calculated | tHL | tHH | - | C | R | |
| - | 24 | 58 | minimum temperature limit for water set, tHL calculated | tHL | tHH | - | C | R | |
|  | 25 | 1 | day temperature set point in cooling | 10 | 40 | 24 | C | R/W | |

| par. | CAREL sup. index | Modbus® index | description | min | max | def. | UOM | R/W | note |
|---|------------------|---------------|--|-----|-----|------|-------|-----|------|
|  | 26 | 2 | night temperature set point in cooling | 10 | 40 | 26 | °C | R/W | |
|  | 27 | 3 | day temperature set point in heating | 10 | 40 | 20 | °C | R/W | |
|  | 28 | 4 | night temperature set point in heating | 10 | 40 | 18 | °C | R/W | |
| dIF | 29 | 5 | temperature differential dIF | 0 | 10 | 1 | °C | R/W | |
| dS1 | 30 | 6 | temperature differential dS1 | -10 | 10 | 0 | °C | R/W | |
| dSA | 31 | 7 | temperature differential dSA | -10 | 10 | 0.0 | °C | R/W | |
|  | 32 | 8 | humidification set point | 10 | 70 | 50 | %U.R. | R/W | |
|  | 33 | 9 | dehumidification set point | 10 | 70 | 70 | %U.R. | R/W | |
| dFH | 34 | 10 | humidification differential dFH | 1 | 20 | 5 | %U.R. | R/W | |
| dFd | 35 | 11 | dehumidification differential dFd | 1 | 20 | 5 | %U.R. | R/W | |
| CAL+Int | 36 | 12 | inside temperature calibration | -10 | 10 | 0 | °C | R/W | |
| CAL+Est | 37 | 13 | outside temperature calibration | -10 | 10 | 0 | °C | R/W | |
| CAL+HUn | 38 | 14 | humidity sensor calibration | -15 | 15 | 0 | %U.R. | R/W | |
| CtS | 39 | 15 | threshold for set point compensation in cooling | 0 | 25 | 10 | °C | R/W | |
| Ctt | 40 | 16 | threshold for set point compensation in heating | 0 | 25 | 10 | °C | R/W | |
| CdF | 41 | 17 | max differential for set point compensation | 0 | 20 | 2 | °C | R/W | |
| CSt | 42 | 18 | parameter for set point compensation | -1 | 1 | 0 | °C | R/W | |
| EHi | 43 | 19 | maximum water temperature for model T+H radiant | 10 | 80 | 40 | °C | R/W | |
| Elo | 44 | 20 | minimum water temperature for model T+H radiant | 0 | 50 | 10 | °C | R/W | |
| tHH  | 45 | 21 | High water temperature limit in heating | 15 | 80 | 45 | °C | R/W | |
| tHL  | 46 | 22 | Low water temperature limit in heating | 15 | 80 | 23 | °C | R/W | |
| tHH  | 47 | 23 | High water temperature limit in cooling | 5 | 35 | 30 | °C | R/W | |
| tHL  | 48 | 24 | Low water temperature limit in cooling | 5 | 35 | 10 | °C | R/W | |
| tAH  | 49 | 25 | High room temperature limit in heating | 15 | 40 | 24 | °C | R/W | |
| tAL  | 50 | 26 | Low room temperature limit in heating | 15 | 40 | 16 | °C | R/W | |
| tAH  | 51 | 27 | High room temperature limit in cooling | 5 | 35 | 30 | °C | R/W | |
| tAL  | 52 | 28 | Low room temperature limit in cooling | 5 | 35 | 16 | °C | R/W | |
| ddP | 53 | 29 | Dewpoint delta for adjusting the water temp. set point | -20 | 20 | 0 | °C | R/W | |
| dFA | 54 | 30 | Water regulation band | 0.1 | 20 | 4 | °C | R/W | |

Tab. 9.f



Note: All the analogue variables (set point, differential, sensor calibration ...) are expressed in tenths if read with the CAREL protocol, and are expressed in hundredths if read with the Modbus® protocol (example: 24.3 °C: CAREL supervisor = 243, Modbus® supervisor = 2430)

9.2 Software updates

From release 2.3 to 2.4:

- Resolved the communication problem between multiple instruments connected in a supervisor network with CAREL protocol

From release 2.4 to 2.5:

- Resolved the communication problem involving the digital variables using the Modbus® protocol
- Changed the maximum allowable limit of the temperature set point from 40 °C to 50 °C.

From release 2.5 to 2.6:

- Increased the speed for reading the temperature + humidity sensor.
- Rearranged operation of T2A mode with AdC=2 and 3.
- Changed the alarm signals.
- Improved errors management in Modbus®.

From release 2.6 to 2.7:

- Updated table 4.g (parameter AUt)

From release 1.0 to 2.0 (only for code ADCF000610):

- Updating parameters: tIA, tDA, dFA;
- Read time of water sensor faster.

CAREL

CAREL INDUSTRIES HQs

Via dell'Industria, 11 - 35020 Brugine - Padova (Italy)

Tel. (+39) 049.9716611 - Fax (+39) 049.9716600

e-mail: carel@carel.com - www.carel.com

Agenzia/Agency: